

meeeeeeew miaaaaau miaaaaaau prr maau nyaaaaa

puua meew miaaaaau nyaaa puua maaaau-pua puuuuuua p'maaau
meeeeew nya nya ,pr m pua **Henrik Lievonen** miaaaaau maaaaau
meew puuuua miau-maaaau puua nyaaa miaaaaau
meew meeeew miaaaau meew

puua 2025

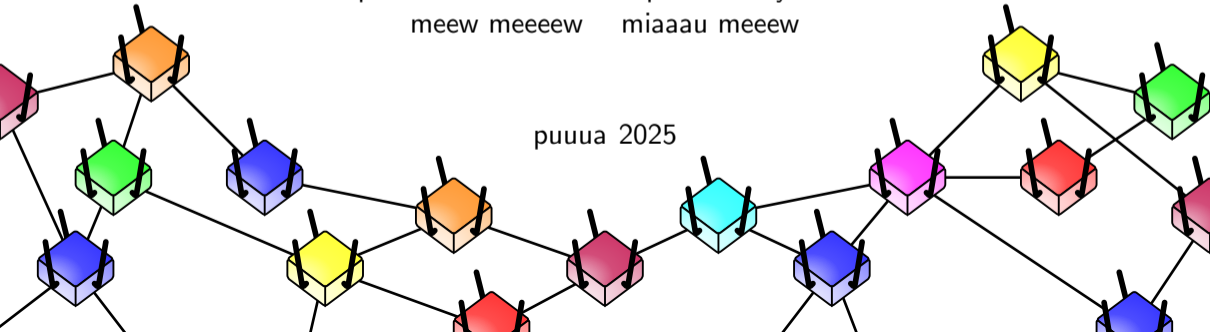

meeeeeeew miaaaaau miaaaaaau prr maau nyaaaaaa

puuuua miaau

maau meeeeeew

mauu

nyaaaaaa m puuuu

miaaaaau

meeeeeeew miaaaaau miaaaaaau prr maau nyaaaaa

puuuua miaau

maau meeeeeew

mauuu

nyaaaaaa m puuuu

miaaaaau

puuuua miaau

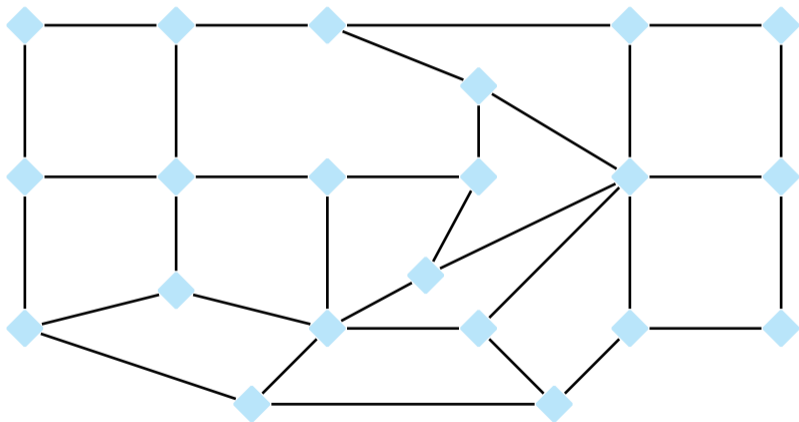

puuuua miaau

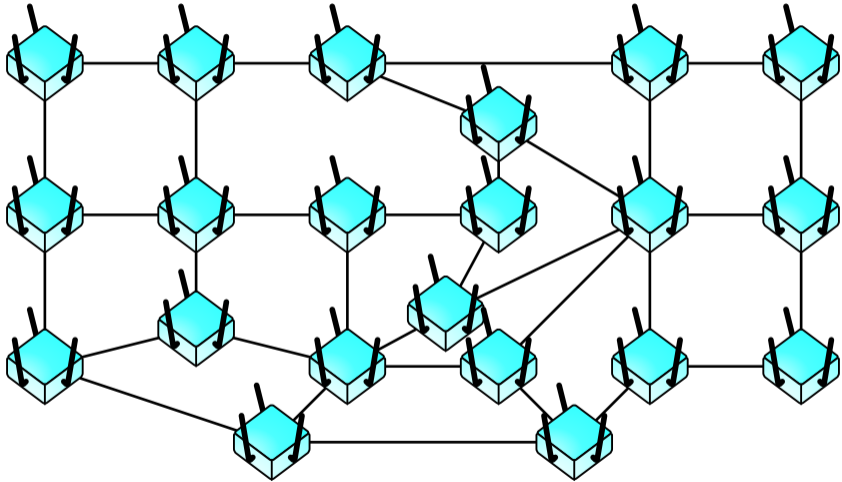

puuuua miaau

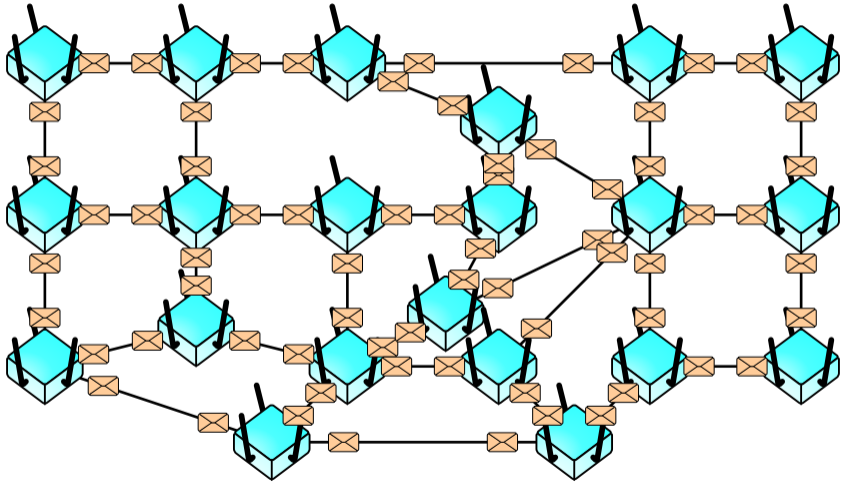

puuuua miaau

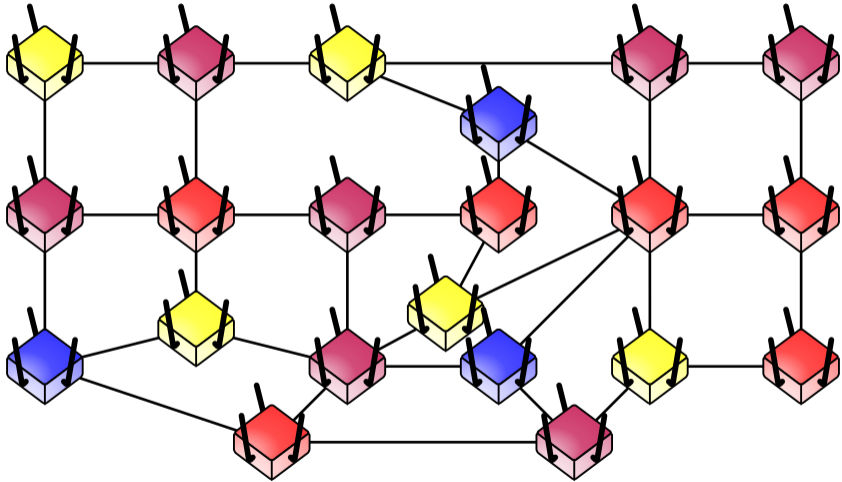

puuuua miaau

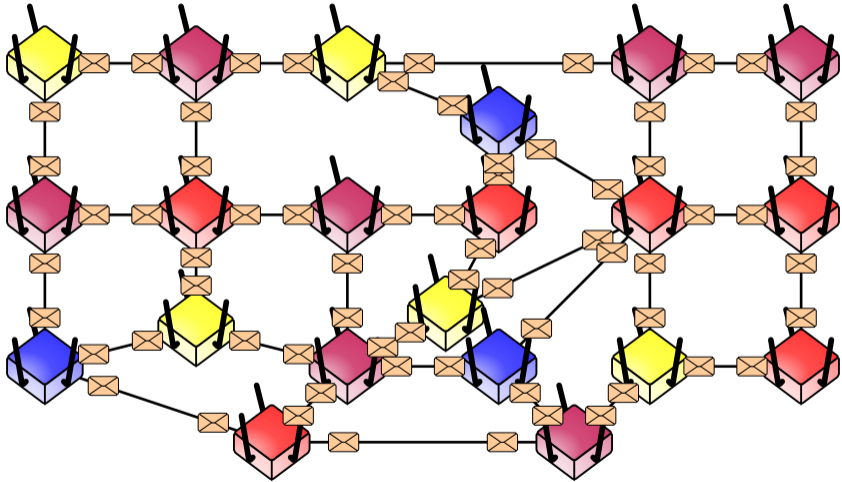

puuuua miaau

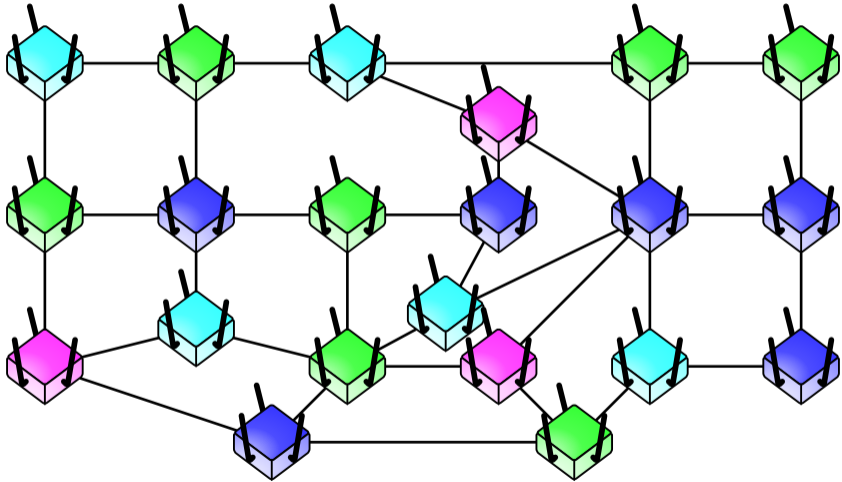

puuuua miaau

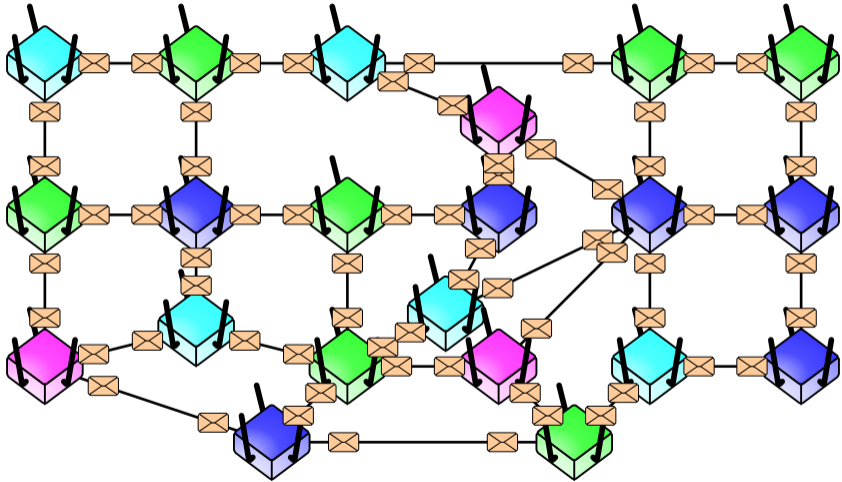

puuuua miaau

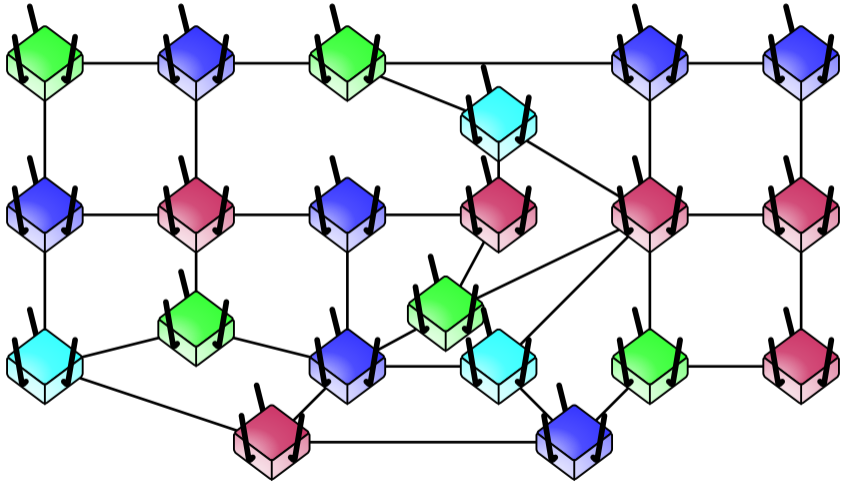

puuuua miaau

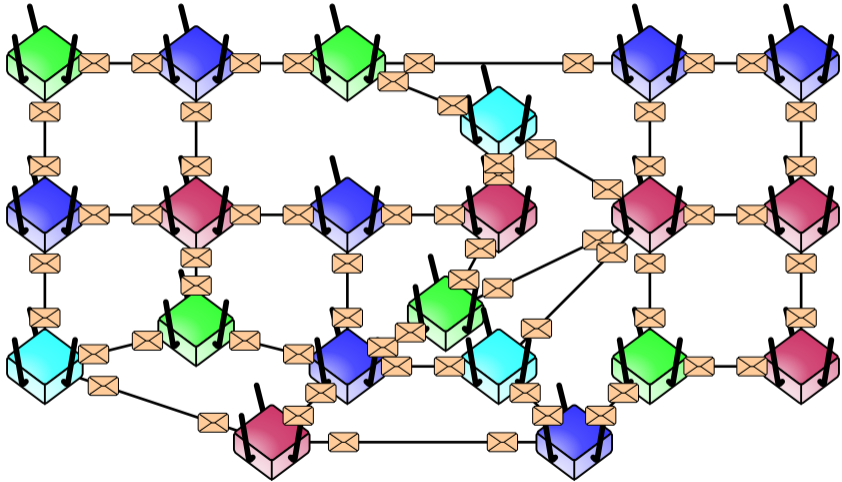

puuuua miaau

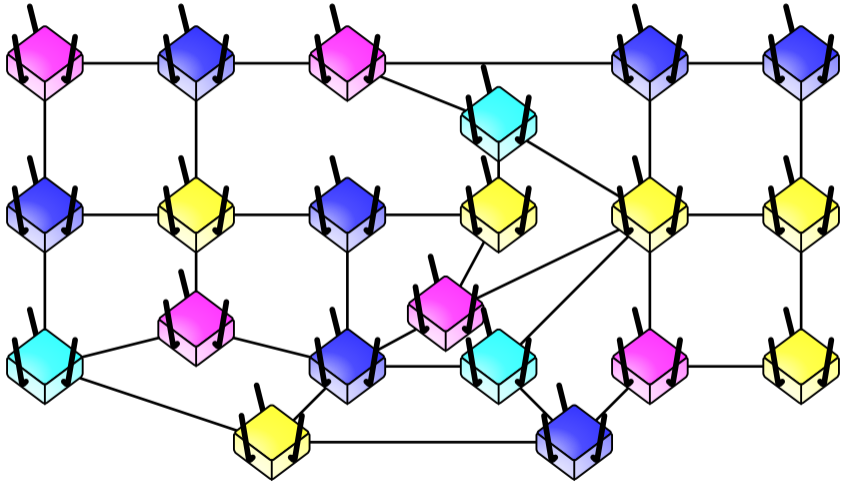

miaaaauu-puuua miaau

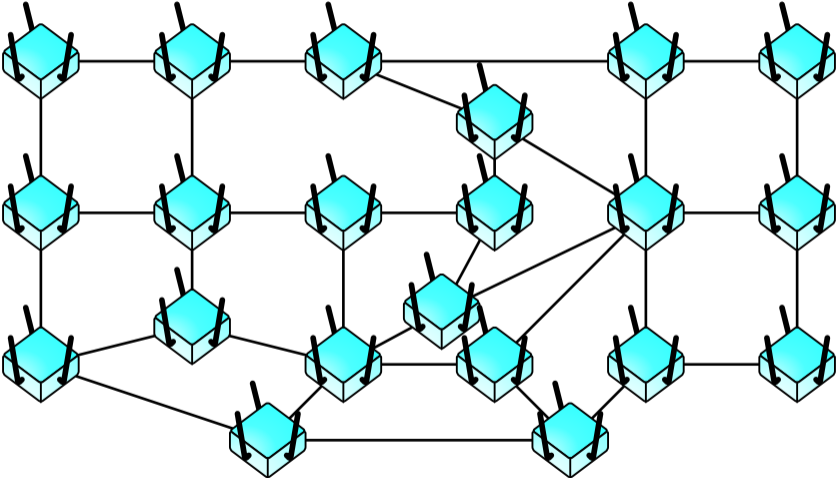

miaaaaauu-puuuuu miaau

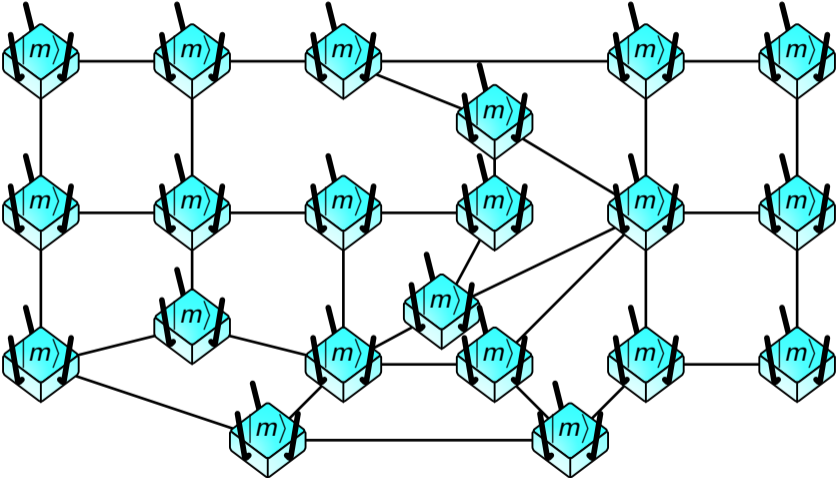

miaaaauu-puuua miaau

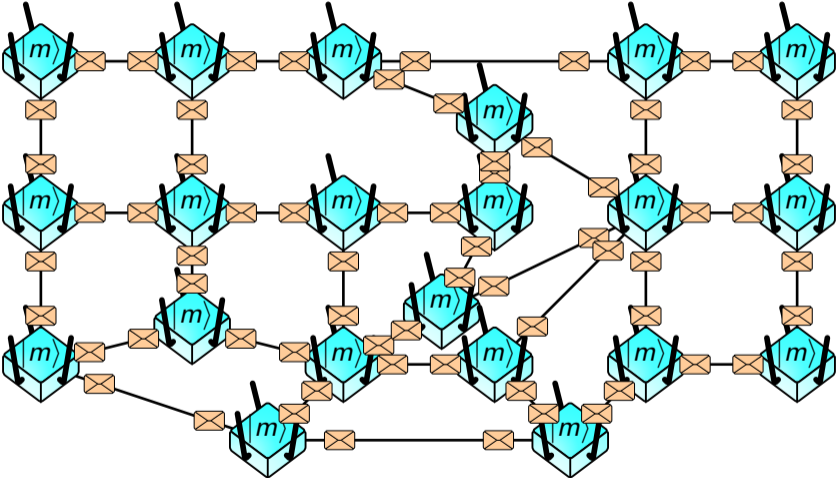

miaaaaauu-puuuuu miaau

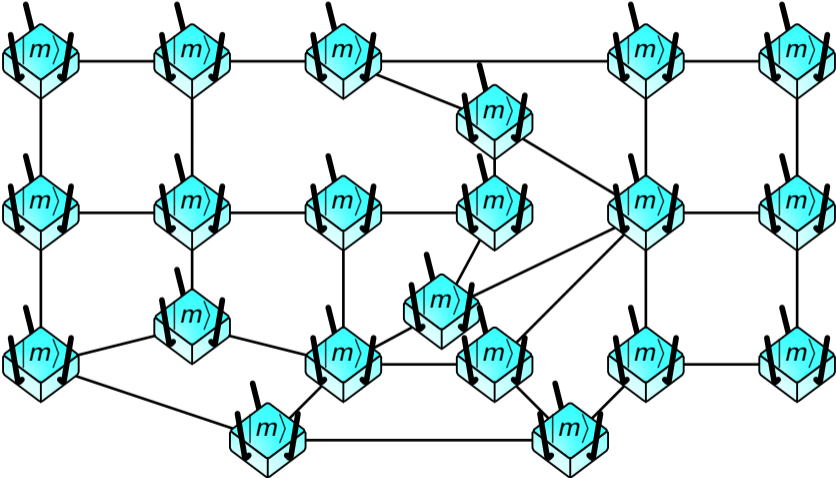

miaaauu nyaa

meeeeew (m pua, maaaaauu, pua miaaaauu 2019)

*meow maau p miaau miaaaaaaauuu meeeow mau nya m puuua mau 2 nyaa m prr
meeeeew-puuuuu miaau, nya maaaau m(p) maauu m prr nyyyaaa puuuua miaau.*

miaaauu nyaa

meeeeew (m pua, maaaaauu, pua miaaaaauu 2019)

*meow maau p **global** miaaaaaauuu meeeow mau nya m puuuu mau 2 nyaa m prr meeeew-puuuuu miaau, nya maaaau m(p) maauu m prr nyyyaaa puuuuu miaau.*

miaaaaauu

	miaaaaauu	miaaaaauu	mauu
miaaaaauu nyaa ¹	$m(p)$	$m(1)$	pr
pua nyaa	$m(\Delta)$	$m(1)$	nya

¹m mrr, maaaaauu, mrr miaaaaauu 2019

meeeeeeew miaaaaau miaaaaaau prr maau nyaaaaa

puuuua miaau

maau meeeeeew

mauuu

nyaaaaaa m puuuu

miaaaaau

maau meeeew

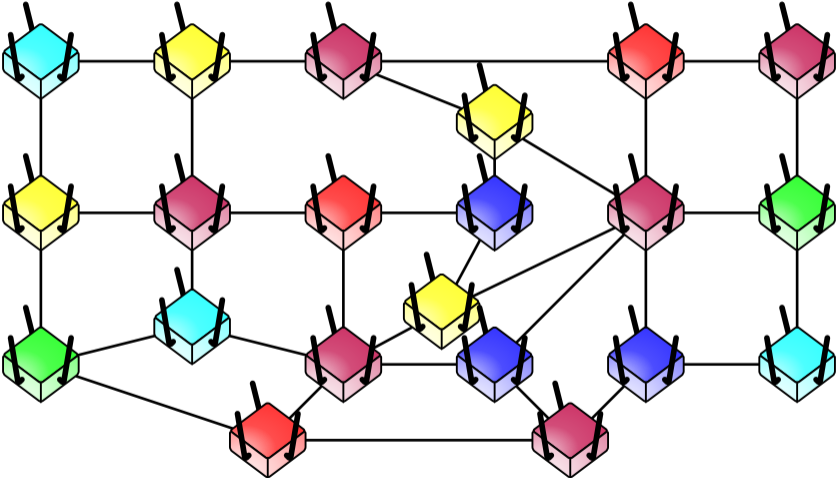

maau meeeew

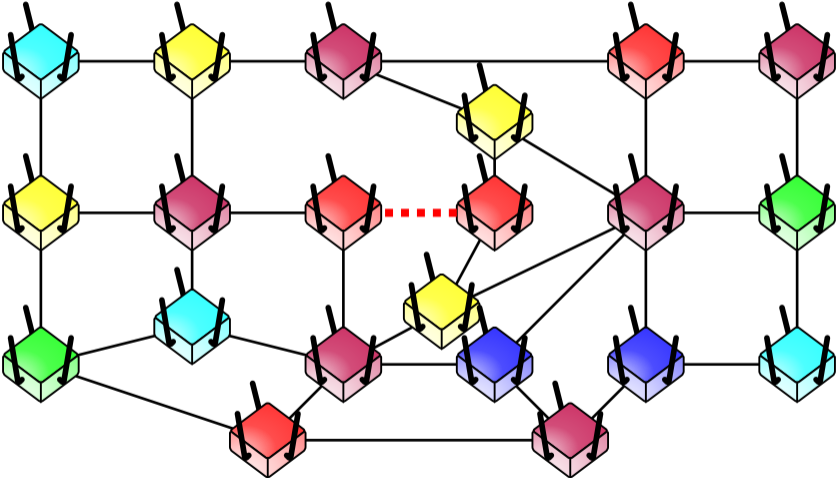

maau meeeew

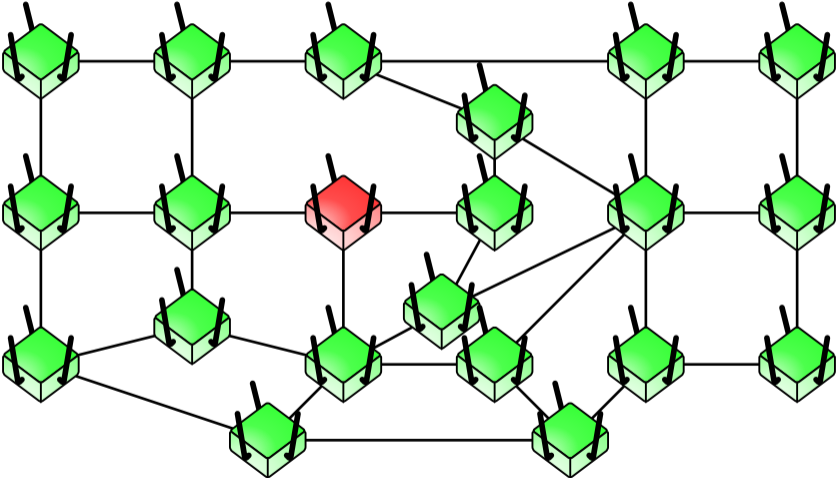

maau meeeew

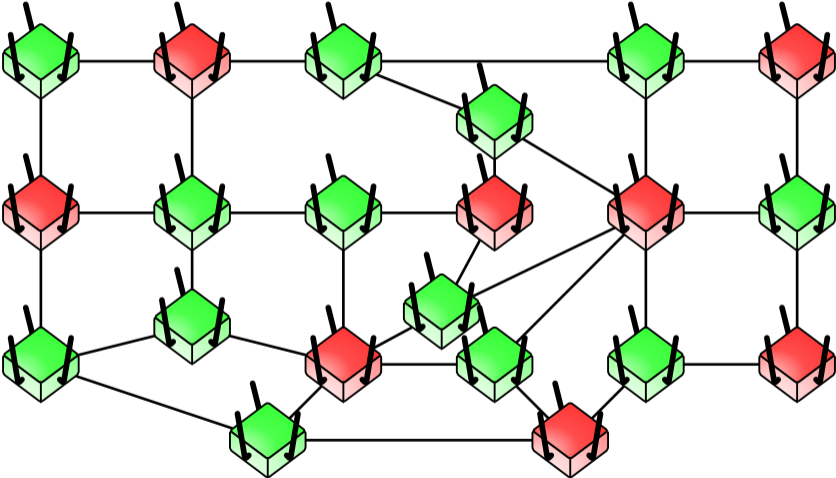

maau meeeew

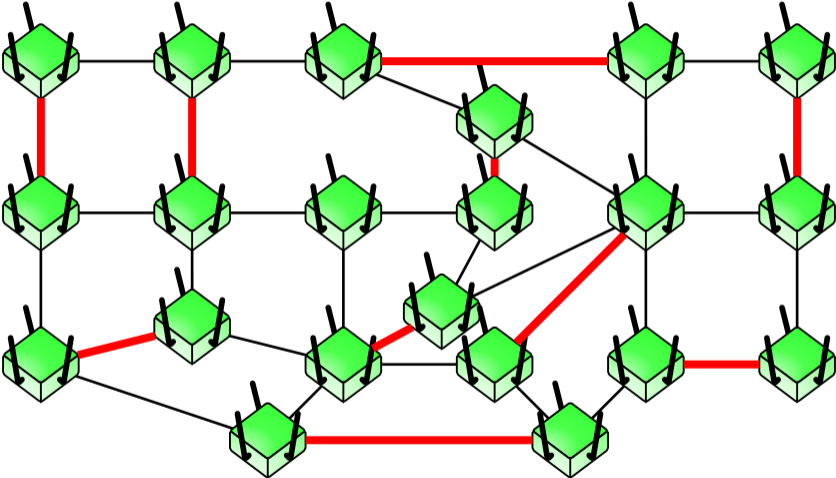

meeeeeeew miaaaaau miaaaaaau prr maau nyaaaaaa

puuuua miaau

maau meeeeeew

mauu

nyaaaaaa m puuuu

miaaaaau

mauu

<u>miaaaau p</u>		
p	p	$p \oplus p$
0	0	0 mau 2
0	1	0 mau 2
1	0	0 mau 2
1	1	1 mau 2

mauu

miau
mau

<u>miaaaau p</u>			
p	p	$p \oplus p$	
0	0	0	mau 2
0	1	0	mau 2
1	0	0	mau 2
1	1	1	mau 2

mauu

miau

mau

<u>miaaaaau p</u>			
p	p	$p \oplus p$	
0	0	0	mau 2
0	1	0	mau 2
1	0	0	mau 2
1	1	1	mau 2

mauu

miau



mau

		miaaaau p	
p	p	$p \oplus p$	
0	0	0	mau 2
0	1	0	mau 2
1	0	0	mau 2
1	1	1	mau 2

mauuu

miau p



mau p

$miaaaau\ p$			
p	p	$p \oplus p$	
0	0	0	mau 2
0	1	0	mau 2
1	0	0	mau 2
1	1	1	mau 2

mauuu

miau $p \longrightarrow p$



mau $p \longrightarrow p$

$\text{miaaaau } p$			
p	p	$p \oplus p$	
0	0	0	mau 2
0	1	0	mau 2
1	0	0	mau 2
1	1	1	mau 2

mauuu

miau $p \longrightarrow p$

..... $(p, p, p, p) \in p$

mau $p \longrightarrow p$

miaaaau p			
p	p	$p \oplus p$	
0	0	0	mau 2
0	1	0	mau 2
1	0	0	mau 2
1	1	1	mau 2

miaaaauu puuuu

miau

mau

<u>miaaaau p</u>			
p	p	$p \oplus p$	
0	0	0	mau 2
0	1	0	mau 2
1	0	0	mau 2
1	1	1	mau 2

miaaaauu puuuu

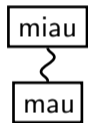

<u>miaaaauu p</u>			
p	p	$p \oplus p$	
0	0	0	mau 2
0	1	0	mau 2
1	0	0	mau 2
1	1	1	mau 2

miaaaauu puuua



<u>miaaaau p</u>		
p	p	$p \oplus p$
0	0	0 mau 2
0	1	0 mau 2
1	0	0 mau 2
1	1	1 mau 2

miaaaauu puuua

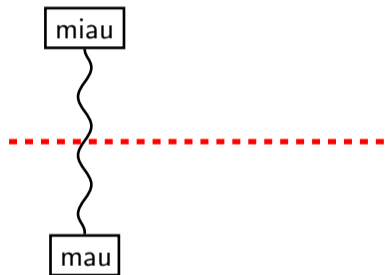

<u>miaaaau p</u>		
<i>p</i>	<i>p</i>	$p \oplus p$
0	0	0 mau 2
0	1	0 mau 2
1	0	0 mau 2
1	1	1 mau 2

miaaaauu puuua

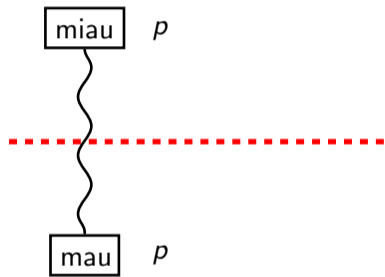

miaaaau p		
p	p	$p \oplus p$
0	0	0 mau 2
0	1	0 mau 2
1	0	0 mau 2
1	1	1 mau 2

miaaaau puuu

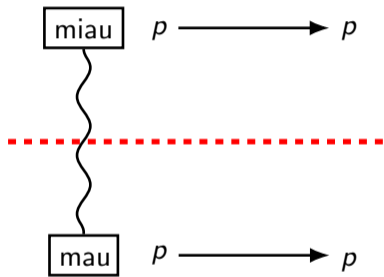

miaaaau p		
p	p	$p \oplus p$
0	0	0 mau 2
0	1	0 mau 2
1	0	0 mau 2
1	1	1 mau 2

miaaaau puua

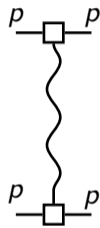
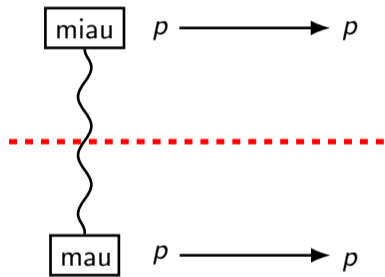

miaaaau p		
p	p	$p \oplus p$
0	0	0 mau 2
0	1	0 mau 2
1	0	0 mau 2
1	1	1 mau 2

miaaaauu puuuu



		miaaaauu p	
p	p	$p \oplus p$	
0	0	0	mau 2
0	1	0	mau 2
1	0	0	mau 2
1	1	1	mau 2

puua² mau

p	p	$p \oplus p$
0	0	0 mau 2
0	1	0 mau 2
1	0	0 mau 2
1	1	1 mau 2

puua² maau

p	p	$p \oplus p$
0	0	0 mau 2
0	1	0 mau 2
1	0	0 mau 2
1	1	1 mau 2

miaaaau meeeoow:

miaaauu

75%

²miaauu, miaau, miaaauu, mrr mau 1969

p_{uuu}^2 mau

p	p	$p \oplus p$
0	0	0 mau 2
0	1	0 mau 2
1	0	0 mau 2
1	1	1 mau 2

miaaaau meeeooow:	
miaaaau	miaaaauu
75%	$p_{rr}^2 \frac{\pi}{8} \approx 85\%$

puua² maau

p	p	$p \oplus p$
0	0	0 mau 2
0	1	0 mau 2
1	0	0 mau 2
1	1	1 mau 2

miaaaau meeeooow:

miaaaau	miaaaauu	mau-maaaauu
75%	$prr^2 \frac{\pi}{8} \approx 85\%$	100%

puuu² maau

p	p	$p \oplus p$
0	0	0 mau 2
0	1	0 mau 2
1	0	0 mau 2
1	1	1 mau 2

miaaaau meeeooow:

miaaaau	miaaaau	mau-prrprpr nyyaa-miaaaau
75%	$\text{pr}^2 \frac{\pi}{8} \approx 85\%$	100%

²miaauu, miaau, miaaaau, mrr mau 1969

meeeeeeew miaaaaau miaaaaaau prr maau nyaaaaa

puuuua miaau

maau meeeeeew

mauuu

nyaaaaaa m puuuu

miaaaaau

meeeeow m puuua

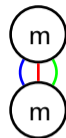
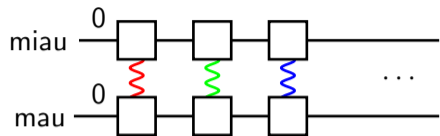

meeeeow m puuua

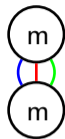
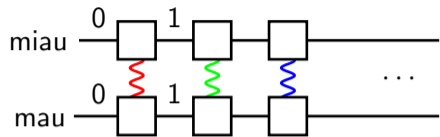

meeeeow m puuua

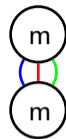
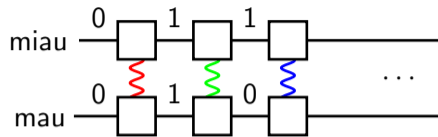

meeeeow m puuua

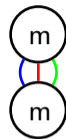
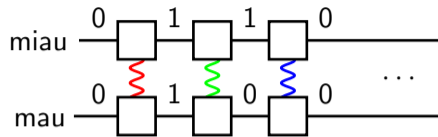

meeeeow m puuua

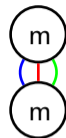
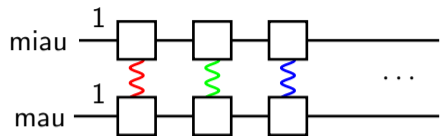

meeeeow m puuua

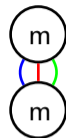
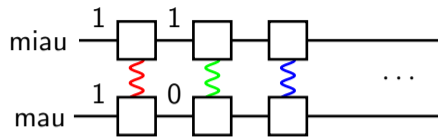

meeeeow m puuua

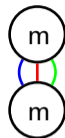
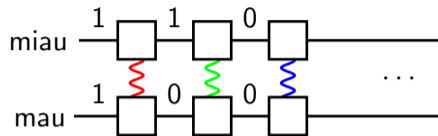

meeeeow m puuua

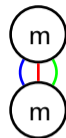
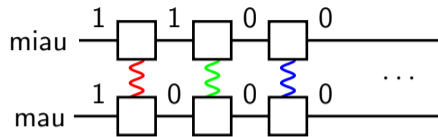

meeeow m puuua

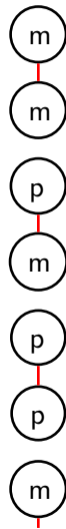
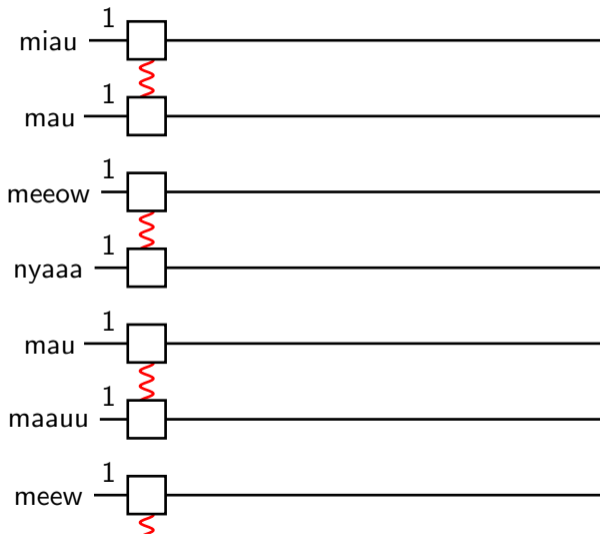

meeeow m puuua

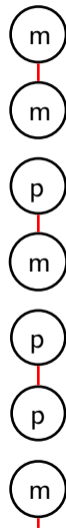
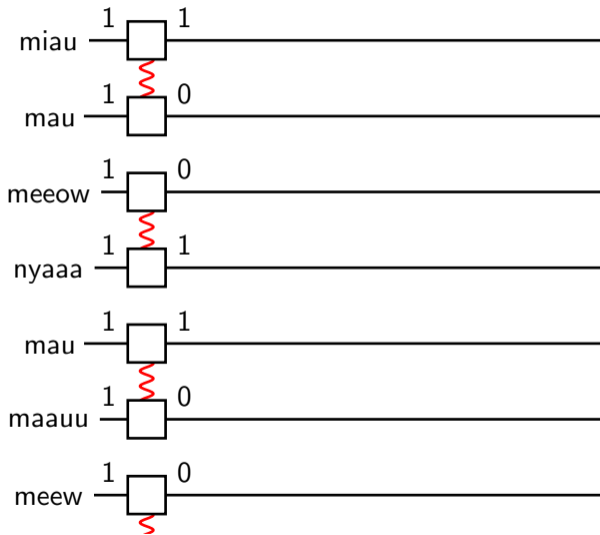

meeeow m puuua

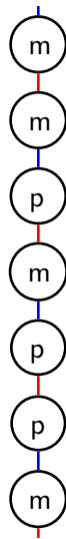
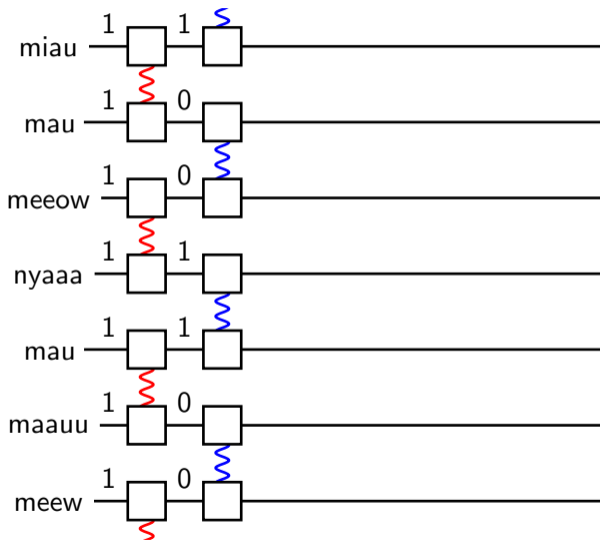

meeoow m puuua

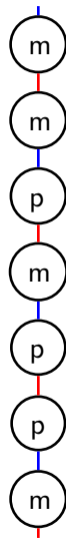
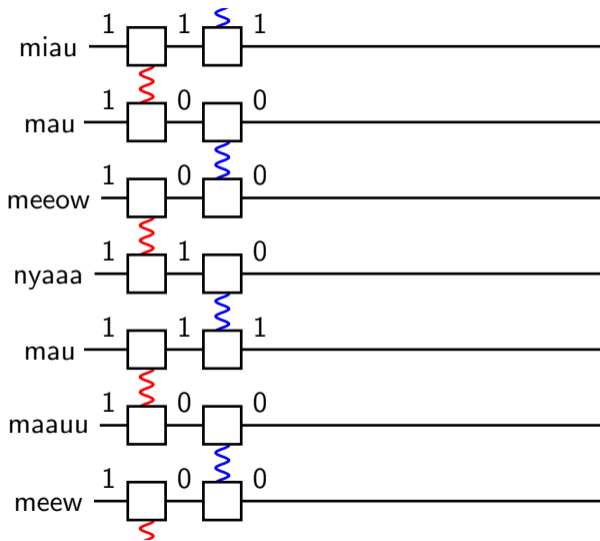

meeoow m puuua

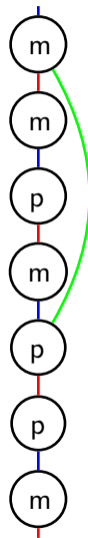
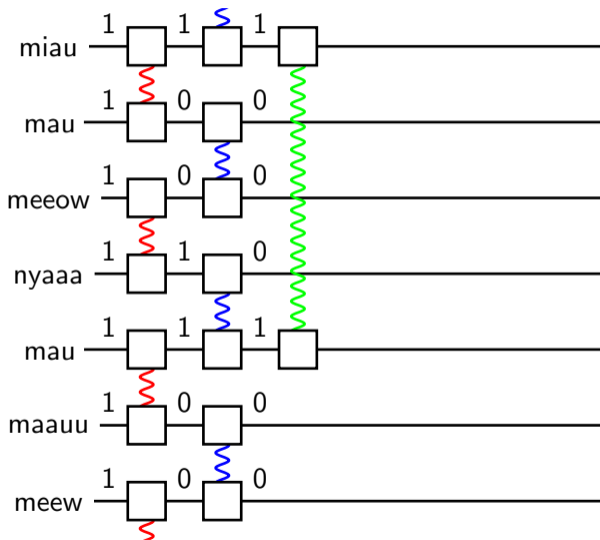

meeeow m puuua

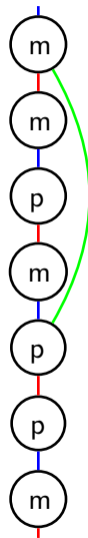
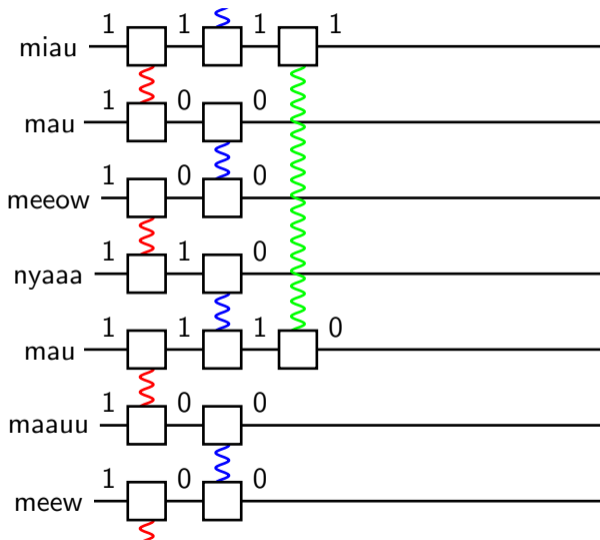

meeeow m puua

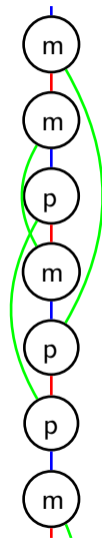
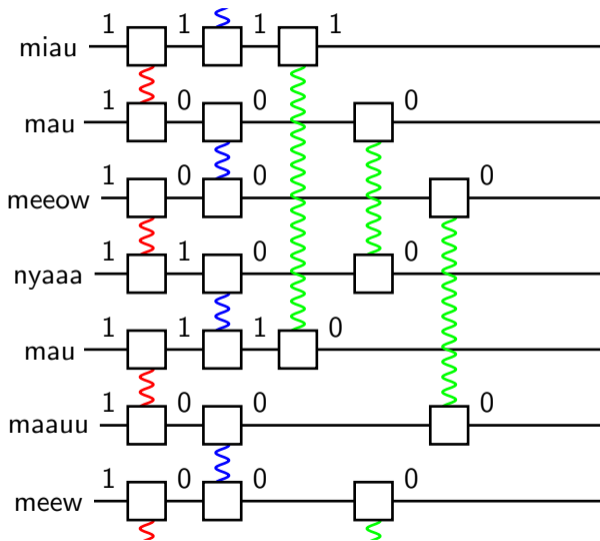

miaaaauu

	miaaaauu	nyyaa-miaaaauu	maau
miaaaauu nyaa ³	$m(p)$	$m(1)$	pr
pua nyaa	$m(\Delta)$	$m(1)$	nya

³m mrr, maaaaauu, mrr miaaaauu 2019

miau⁴ mau

p	p	p	$p \oplus p \oplus p$
0	0	0	0 mau 2
0	1	1	1 mau 2
1	0	1	1 mau 2
1	1	0	1 mau 2

⁴miaaaauuuu, miaau, mrr miaaau 1989

miau⁴ mau

p	p	p	$p \oplus p \oplus p$
0	0	0	0 mau 2
0	1	1	1 mau 2
1	0	1	1 mau 2
1	1	0	1 mau 2

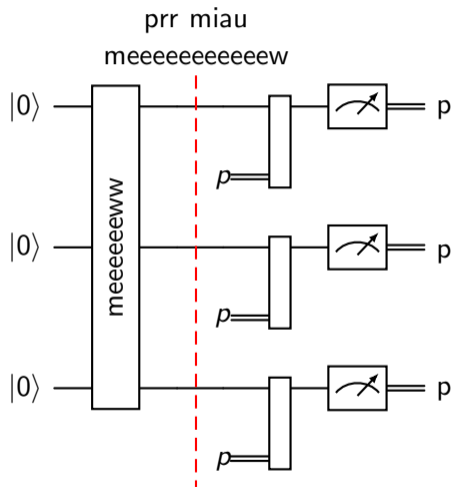

⁴miaaaaauuuu, miaau, mrr miaaaau 1989

meeeeew miaaaauu miaaaaauu prr maau nyaaaaaa

puuuua miaau

maau meeeeeew

mauuu

nyaaaaaa m puuuu

miaaaaauu

miaaaauu

	miaaaauu	miaaaauu	maau
miaaaauu nyaa ⁵	$m(\rho)$	$m(1)$	pr
pua nyaa	$m(\Delta)$	$m(1)$	nya



⁵m mrr, maaaaauu, mrr miaaaauu 2019

miaaaauu

	miaaaauu	miaaaaauu	maau	meeeeow Δ
miaaaauu nyaa ⁵	$m(p)$	$m(1)$	prr	nya
pua nyaa	$m(\Delta)$	$m(1)$	nya	prr
maaaau nyaa	$m(\text{prr } p \cdot \frac{\log \log n}{\log \log \log n})$	$m(\text{prr } p)$	nya	nya

⁵m mrr, maaaaauu, mrr miaaaaauu 2019

nyyyyaaaaa

-  miaauu, miau p., maaaau m. miaau, miaau puuuuuu, pua maaaau m. mau (1969). “nyyaaaaa nyyyyyaaaa m mau maau miaaaau-nyyyaaa miaaaau”. m: *meeoow nyyaaa nyyaaa* 23.15, prr. 880–884. DOI: 10.1103/prr.23.880 .
-  meeeeeeeew, puuuu m., maaaau m. miaau, pua puuuu puuuuuu (1989). “meow puuuuu pua’p meeeew”. m: *pua’p meeeew, miaaaau nyyaaa pua meeeeeeeew m prr miaaaau*. miaaaau miaaaaaauu, prr. 69–72. DOI: 10.1007/978-p94-p017-p0849-p4_10
-  m pua, nya ,pr, meeeeoow maaaaauu, pua maau miaaaauu (2019). “miaaaauu miaaaauu prr prr puuuuu puuuu m puuuuuuuu meeeeeew”. m: *36m meeeeeeww nyyaaaaaaa prr meeeeeoow maaaau m puuuuuuuu puuuu, miaaaau 2019, puuuu 13-16, 2019, meow, meeeew*. prr. m mau miaaaaaauu pua miaaaaaau mau. nya. 126. puuuu. miaauu meeeew - nyyaaa-puuuuu p”p nyyyyyaaaa, 49:1–49:14. DOI: 10.4230/prr.prr.2019.49 .