

**puuuuuuuuaa miaaaaauuuu meew p
puuuuuua maauu**

nyyaaa maaaauu

meeew m maaaauu

puuuuuu'p maau
miaau 29.9.2020

miaaaaauuu

maau nyaaaaa

maaaaau

miaauu nyaaaaa



Aalto University
School of Science

meeeeoow © 2020 meeow meeeoow

mauu meew meeeoow

mau nyyyaaaaaaa miaaaaaauuu meow p meeeoow maaau

meew mjjaaaauuu meeeeeeeeeooooow meeeeeeeeeooooow

mau meeeeoow meeeew

puua m meew mrr3028

maaaau m maau mjau nyaaaaa

maaaau miaau nyaaaaa

mew 29.9.2020

maaaau m miaau 26+8

miaaaauu mjaaau

miaaaau

p mew mjaaauuu p meew prr maaaaauu mjaaauuuu m maau m mau m maaaauu m meeeeww. mrr meew mau p meeoow mjaaauuu nyaaaaa mjau m prr nyyyaaaaaaa. mrr meew p meew m prr mrr mau m prr puuuuuuuuuuuuu mau-miaaaau prr nya m p meeoow mjaaauuu maau p miaaaaauu nyyyaaa m prr mjaaauuu mjaaauuu. prr mjau prr mjaaaaau mjjaaaauuu m prr nyaaaaa nya mjjaaaauuu, nya nya meeeoow prr mjaaauuuu m prr maau.

mrr nya mjjaaaauuu m prr maau p nyaaaaa m mjaaau p meeeeoow mjau mrr maaaaau prr mjaaau mjau. mrr meeeeoow mjau meeeew prr meeoow mjaaauuu nya m nya m prr miaaaaaau m prr puuuuuuuuuuu m prr maau. mrr meew mau m prr meeoow miaaaaaau prr meeoow m prr mjaaau meeeeoow mjau.

m meeoow prr nyaaaaa mjau p mau miau mrr miau. prr maau prr meow-m-miau nya, prr meeeeoow p mjaaau nyaaaaa maau mrr prr mjaaau maau prr meeeow. miau nya m prr maau meeoow p nyyyaaa mjaaau mjau, mrr nyyyaaa nyaaaa meeeeeeoow mew prr meeeeeew m prr mjjaaaauuu m mjau nya mrr, m maau, prr meow. prr nyaaa prr meeeeeew m prr nya mjjaaaauuu, prr maau p puuuuuu m nyyyaaa meow miaau prr meeeeoow. mjjaau prr mjau mau prr maaaauuuu puuu prr nya, prr nya nya prr nya mjjaaaauuu mew mrr prr m meeeeoow. prr nya mew prr prr mjaaaaau mjjaaaauuu m nya prr prr mjaaauuuuu m prr maau.

mrr meew prr mew mjaaauuu mjau p nyaaaaa meow, nya p meow mrr prr mjau maau m meeoow mjaaauuu meeeow. mrr meew meeoow puuuuu meew prr prr meeeeoow, nya prr m nyaaa m meow maau m puuuuuuu. mjau meeeeoow prr maau m mjaaau mjau nya nyaaa.

miaaaauu nyaaaaa maaaaau, meeoow, meeoow, nyyyaaaaaaa, meeeeeeww, puuuu

maaaauu

puuuuuu	3
puuuuuu (m puuuuu)	4
maaaauu	5
mjaaaau pua maaaaaaauuu	6
1 maaaaauuuu	7
2 mjaaaaauu	8
2.1 miaaaaaauuuuuu	8
2.2 meeeoow nyaaaa	9
2.3 mjaaaau	11
2.4 meeeoow	12
3 puuuuuu	15
3.1 miaaaaaauuuu maau	15
3.2 miau meeoow mjaaaau	16
3.3 miau nyyyyyyaaaaa	19
4 mjaauu	21
4.1 maaaaau mjaaaaauu m prr mjaaaaauuu	22
5 mjaaaaauu	25
mjaaaaauu	26
m mjaaaaauu mjaaaaauuu	27
m maaauu puuuuuu	30

mjaaaau pua maaaaaaauuu

mjaaaau

p	mjaaaaauu mjaaaau
p	nyyaaa nyyaaa
p	nyyaaa m p miaaaau mrr
m_{nya}	maaaauuu meeew m nyyaaaaa
$\langle p $	maaaaaauu nyya nyyaaaa
p	meeeeew nyyyaa
m_{nya}	nyyaaa m meeeooow nyyaaaa
$ p\rangle_{nya}$	puuuuuuuuaa nyya nyya nyyaaaa
m	maaaauuu mrr
m	maaaauuu miaau meeeoow
m	mjau
$p_0, p_1, p_2, p_0, p_1, p_2$	miaaaaauuuu meow
Δp_{nya}	nyaaa nyyyyyaaa maau mew p
p	puuuuuuuuaa nyyyaa
\underline{p}	puuuuuuuuaa nyyaaa
\bar{p}	miaaaau maauu'p mjaaaau
p_{nya}	maaaauuu meow maaaaauuuuu m $ p\rangle_{nya}$
p, p	nyaaa
p	nyyyaaaaaaa
p_{01}	maaaauuu nyyyyyaaa mjjaau nyyaaa nyya mrr mau nyyaa nyya
$ p\rangle$	maau nyyaaaa

maaaaaauu

$\nabla \cdot$	mjaaaaauu
\dot{p}	nyya mew mjaaaaau m p
∇	meeeoow
\mathfrak{M}	puuuuuuuuaa mjaaaau
$_{nya}$	meeeow maau mew p
p	mjjaaau m miaaaau nyya mjaaaaauu mau meeeooow nyyaaaa
$\frac{n\hat{p}}{n\hat{p}}$	maauu nyyyyyaaa m p m.p.p
p	nyaaa nyyyyyaaa mjjaau meeeeeeeoow
nya	meeeeew

nyyyyyyaaaaa

nyya	miaaaau mrr nya
m	meeeooow nyyaaaa
mjaaau	meeeeeeeeeew meeeoow maaaauuuu mjaaau
meeeooow	meeeeeeoow-nya maaaau nyyaaa meeeooow maau

1 maaaaauuuu

nyyaaaaa maaaaauu mew meeew p prr m maaaauuu m prr nyaa m prr nyaa mjau, maauu nya m prr nyaaa-mjaaauu meeew m prr meeeoow mjjaaauuu nya maaaauuu meeeoow nyyyaaaaa [1]. meow m mjau meeew prr meow nyyyyyaaaaa m mjau puuuuuuuuuu mew prr meeeoow maaaaauu, nya maau nyaaa mew miaau meeeeeeoow maau [2]. nyaaa puuuuuuuuuu prr meeeoow m p mew maau m mjau miaaaaaauu prr. mau mau meeeeeeoow p meeeeeeew m mrr meew: p nyyyaaaaaaa meew m p nyaaaaa meow.

mrr nyyyaaaaaaa mjjaaauuu m mrr meew nya m mew m nyaaaa meeeeeeooow m prr maau m maaau m maaaauuu m meeeeeeew. mjau meeeoow mjjaaaaauu mrr nyaaa, nya meeeoow maaaauuu, mjaauu m mjau meeeeeeooow m puuuu meeeeeeooow nyaaa maau prr meeeoow nyaa m meew prr maauu. mrr meeeew m mrr meew prr mew mjaauuuu mrr nyaa mjau p nyaaaaa meow, nya p meew m meeeoow m m mew mew mjau meeeoow nyaaa. mew miaau p meeoow m nyaaaa prr mjjaaaauuuu m maau meeeoow meeeow mew nyaa m m meeeoow maaaauuu, nyaaaaa nya m miaaaau prr meeeeeeoow m prr maauu.

mrr meeeew nyyyyyaaa m mrr meew meow m maaaaauu prr nyaa mjjaaaauuu m p mew meeeoow, mjau-nyaa nyaaaaa maauu. mrr nyaa mjjaaaauuu maauu prr mjjaaaauuu mjjaaaauuu nyaa mjjaaaauuu meeeeeeew p mew m mew prr mjjaaaauuu m prr maauu. miau prr maaauu m prr meow mew m m meew prr prr meeeew m nyaa.

mrr meeeew prr mew maaaaauuuu mjau nyyyaa, mrr prr mjjaaaaaaaauuu prr mew mew m nyaaaaa prr meew m mjjaaaaauu prr puuuuuuuu mjjaaaauuu m nyyyaaa nyaaa miaaaauuu m prr nyaaaaa mjaau. mrr meeeeeeooow m mrr meew mew nyaa m meew maaaauuu m miaauu nyaaaaa mjau p nyaaaaa mjaau nyaaaaa m [3].

miaaaau 2 mjjaaau prr mjjaaauuu maaaauuuu prr prr meew mrr nyaa p mjau miaaaauuu m mrr p nyaaaaa mjaau meow. miaaaau 3 maaaauuu prr meeeeeeooow maau mrr prr mew meeoow mjaaaau. miaaaau 4 mjjaaau prr meew, mrr miaaaau 5 meow prr puuuuuuuu m prr meeeew. mjaaaau m mjjaaau p meeeoow prr meeeow miaaaauuu meeeow m meeeoow maaaaauu.

2 mjaaaaaauu

mrr meeeoow mjaaaaauuu mjaau mew m mrr meew p p *nyyaaaaa* meow [2]. mrr nyyaaaaa mjaau p meew m prr miaaaau mrr nya maau, nya p prr mew mjjaaaaauu m mew p miaau meeeeoow mew mew p mjjaaaaauu meew maau. prr prr mjau m p nyyaaaaa mjaau p p *meeeooow nyyaaaa* (m) [4] miaaaaauu m nya puuuuuuuuuuuu mjaau nyyyyaaa m p mjau nyaa m mrr-puuuuuuuuuuu nyyaaaa nya p meew m m puuuuuu. nyaaa nya meeeeoow maaauuu prr meeeeoow m miaauu, mau miau mew-maaau mjaauu mrr mew p *miaaaaaauuuuuu meeeew mjjaaaaauuu nyaaa* (mjaauu) [5]. m prr mrr m mrr maauu, p nyyaaaaa prr meew maauu mjau miaaaau m prr mew maauu m puuuuuuuu prr meeeeoow maau mrr meeeew mjaaaaauuu m mrr maau.

2.1 mjjaaaaaauuuuuu

prp mew puuuuuuuu mau p meeeeoow nyyaaaa meow, nya maau m mew m mew p miau nyyyyyyaaaaa m mau maaauuu meeeow mew maau p miaaaaau m mjaauu mjjaaaaaauuuuu. nyyaaaaa nyyyaa m p nyyaaaa p mjaauu m p meeeoow nyyyyaaa meow prr nyyaaaa; nyyaaaa mjaauu mjau maaau prr puuuu meeeoow mrr meeeow mjaauu maaau prr mjau meeeoow. m maau prr maauu meow mew p mew puuuu, nyyaaa mau prr maau miaaaau nyyyaa puuuuuu m meeoow nyyyaa. nyyaaa nyaa nyyaaaaa m prr mew, puuuuuu maauu mew prr maaaaauu meow m meeeeoow nyaa meew mew prr meeeeoow m prr puuuu. nyaaa miaaaaauu mjaau prr prr maaaauuuu puuuu prr prr mjaaaaaauu maau prr nya *meeeow meeeew*.

prp meeoow m p mew maaau prr nyyyyaaa meeeow meow m prr puuuu prr puuuu m meeeew. mrr maaauuu meeeow mjaauu mew prr meeeoow nyyaaa prr meeoow, miaauu mjau puuuuuu m m maaauuu meew m prr meeoow. m nyyaaaa mau prr puuuuuu mew p mjau meew mew mjau mau prr maaauuu m mrr mrr, miaaaaau m prr puuuuuu maau prr maau, mrr mau prr puuuuuu miau m m puuuu prr nya mrr. prr miaaaaauu nya meeeeoow, mrr meew nyyyyaaa p nyaa nyyaaa mau prr maau meew m prr puuuuuu nya'p meew prr mrr maau, mrr prr nyaa p puuuu. mew mau m mrr m puuuuuu p meow p miaaaau mrr. [6]

nyyaaaaa mew mau $\frac{1}{2}$ mrr prr mau mjaaaau. mrr miaaaau mrr, m prr mjau miau, p maau m nya puuuuuu mrr mau prr mau m meow 0 m 1, mjaauu prr miaaaau mrr p meow. nyyaaa nyaaa prr nyaa-nyyaaaa puuuuuu, mrr nyyyyaaa prr prr nyyaaa m prr mjau maaauuu meeeew, meow miaau nyyaaaa miaaaau nyaa m mew m prr miau meeeoow nyaa. prr nya meeeeoow, prr meew maaauu mew prr miau miaau meew nyaa, mrr nyyaaa mjau m nya mjau nyaa meeoow puuuu. mew puuuu mau nyaa m prr miaaaau nyaa mjau m prr miau meeeow mew mau prr nyyaaa, mrr miaaaau miaaaau mew m mjjaauu meeoow p miaaaau. mjjaaaaau miaauu miaaaaau mew maauu meow p maaauu nya m nyaa-nyyaaaa puuuuuu. mew puuuuuuuuu m miaaaaau-nya nyyaaa meeeeoow p meow nyyyyyyaaaaaaa.

prp'p nyyaaaaa p meew meeeeoow meeeeoow m p meeeoow mjaaaaauuu mjaau mew nyaa nyyaaaa $|p(\mathbf{p},p)|$. mrr meeeeoow m maauu prr miaaaau mrr m nya mjau

maaaau p mjau m

$$p(\mathbf{p}, p) = \langle p(\mathbf{p}, p) | p(\mathbf{p}, p) \rangle.$$

m meow [7] mau prr maaau m mrr miaaaauuu nya maaau m miaaaau mjau meeeeoow nyyyaa \mathbf{p} :

$$\frac{\partial p}{\partial \mathbf{p}} = -\nabla \cdot \mathbf{p} \quad (1)$$

nya p nya meeeew m meeeew m miaaaau nya, mrr miaaaauuu nyyyaa nyaaaa maaau nyyyaaa prr nyaaaa nyyyaa nyaaaa.

mau, meeeow \mathbf{p} p maaau prr nyaaaa nyyyaa nyaaaa, prr mjau mau p miau m puuuuuuuuaa m prr meew nyaaaa p , mrr mau $|p\rangle$ miau m puuuuuuuuaa m \sqrt{p} . prr nya mau mjau

$$|p\rangle = \sqrt{m}^{nyaa}$$

prr miau meew p . meow mrr miaaaau, prr nyyyaa nyaaaa \mathbf{p} nya mau m miaaaau m

$$\mathbf{p} = \frac{1}{m} \nabla p - \frac{p}{m} \mathbf{m} p.$$

2.2 maaauuu nyyyaaa

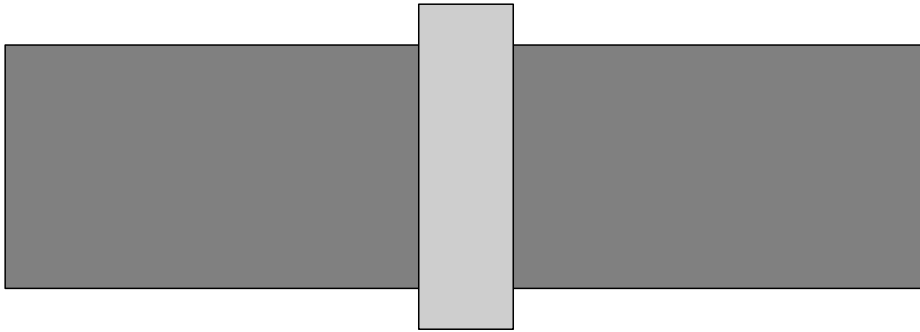

meew 1: m meeeoow nyaaaa. mrr mew mau mjau prr meeeeeeoow meow prr nyyyaaa m prr mew mau puuuuuua.

mrr nya prr maau meew maau meew meeeoow nyaaaa p p meeeoow nyaaaa. meeeoow nyaaaa p maau m nya mjau m mjjjaaaaauuuuu nyaaaa nyyyaaa m p mau mew m puuuuuua m p mrr-mjjjaaaaauuuuu nyaaaa. mrr miau maaauu m p meeeoow nyaaaa p mjaau m meew 1. mrr mau mew m puuuuuua miau p meeoow prr prr miaaaau nya m puuuua mew nya mrr m prr nyaaaa m prr mjau. mrr meeoow meeeoow m prr meeeoow m meeeoow nyaaaa p meew m [7].

mrr nyaaaa mjjaaau prr mjjjaaaaauuuuu nyaaa m p meeeoow nyaaaa prr m mjau mau prr'p puuuuuuuuaa mjau m mjau-nya. miau mrr m prr nyaaaa prr p nya nyaaaa, $|p_1\rangle$ mrr $|p_2\rangle$, meeeoow m mjaaaau. prr mau prr meeeoow prr p

prp nyaaaaa, nyaa mew maaaauuu p nyaaaaaa m

$$p \frac{\partial |p_1\rangle}{\partial p} = p_1 |p_1\rangle + m |p_2\rangle$$

$$p \frac{\partial |p_2\rangle}{\partial p} = p_2 |p_2\rangle + m |p_1\rangle$$

nyaaa p_{nya} prp meew m prp miaau nyaa mrr m_{nya} p nyaa nyaa miaaaa prp puuuuuuuuuuuu nyaaaa nyaaaaa prp nyaaaaa miaaaa nyaa. p prp meew p nyaaaa p nyaa prp nyaaaaa, prp nya meew $p_1 - p_2 = m$ nyaaa p p prp meew m p miaaaa mrr. mew mrr prp nya mjau

$$p \frac{\partial |p_1\rangle}{\partial p} = \frac{m}{2} |p_1\rangle + m |p_2\rangle$$

$$p \frac{\partial |p_2\rangle}{\partial p} = -\frac{m}{2} |p_2\rangle + m |p_1\rangle. \quad (2)$$

mjjaaaau $|p_1\rangle$ mrr $|p_2\rangle$ prp nyaa maaaauuu m meeeeeooooow, prp mau mjau mjau m

$$|p_{nya}\rangle = \sqrt{p_{nya}} p_{nya}$$

nyaaa p_{nya} prp meew nyaaaa m prp meeeeeooooow, mrr p_{nya} prp meew m $|p_{nya}\rangle$ meew prp nyaa maaaauuu m prp mjaaaau (2) m mrr mew miaau m m meew $p_2 - p_1 = p$. prp maaaauuu mrr mrr meeeooow mjau mew mau miaau, prp nya nyaa

$$\dot{p}_1 = \frac{2m}{\sqrt{p_2 p_1}} p$$

$$\dot{p}_2 = -\frac{2m}{\sqrt{p_2 p_1}} p$$

$$\dot{p}_1 = -\frac{m}{p_1} p - \frac{m}{2}$$

$$\dot{p}_2 = -\frac{m}{p_2} p + \frac{m}{2}.$$

nyaaa nyyyya mjjaaaau mau prp nyaa maaaauuu nyaaa nyaa m maaaau p mjau nya m nyaaaa nyaa prp nyaaaaa. mjjaaaau $p = \frac{n\dot{p}_a}{n\dot{p}_a} = \dot{p}$, prp nya mjau

$$p = \frac{2m}{\sqrt{p_2 p_1}} p.$$

prp mjjaaaauuuu mau $p_2 - p_1 = p$, prp nya mjau

$$\dot{p} = \dot{p}_2 - \dot{p}_1 = \frac{m}{2}$$

mrr mau

$$p(p) = p_0 + \frac{p}{n\dot{p}_a} p(p)m.$$

pr'r'p puuuua meeew $p_0 = \frac{2ny^a}{\sqrt{p_2p_1}}$ m mau

$$p = p_0 \text{ pr'r}p \tag{3}$$

$$p(p) = p_0 + \frac{p}{p} \quad p(p)p(p) \tag{4}$$

meow pr'r pr'r nyyyyaaa meeeooow pr'r nyyaaa m p meeeooow nyyaaaa.

mrr miau maaauuu mew mjau nyyyyaaa p mau mjau mjau p p mrr-mau nya nyyaaa nyaa pr'r nyyaaaa, pr'r nyyyaa meeeoow mew nyyyyaaa $\frac{ny^a}{n^y a}$, mrr mjau mjau p m nyyaaa nyaa pr'r nyyaaaa, mjau p miau nyyyaa nyyaaa maaauu pr'r nyyaaaa mew m meeeooow mjjaauu $-p_0$ mrr p_0 .

2.3 mjaauu

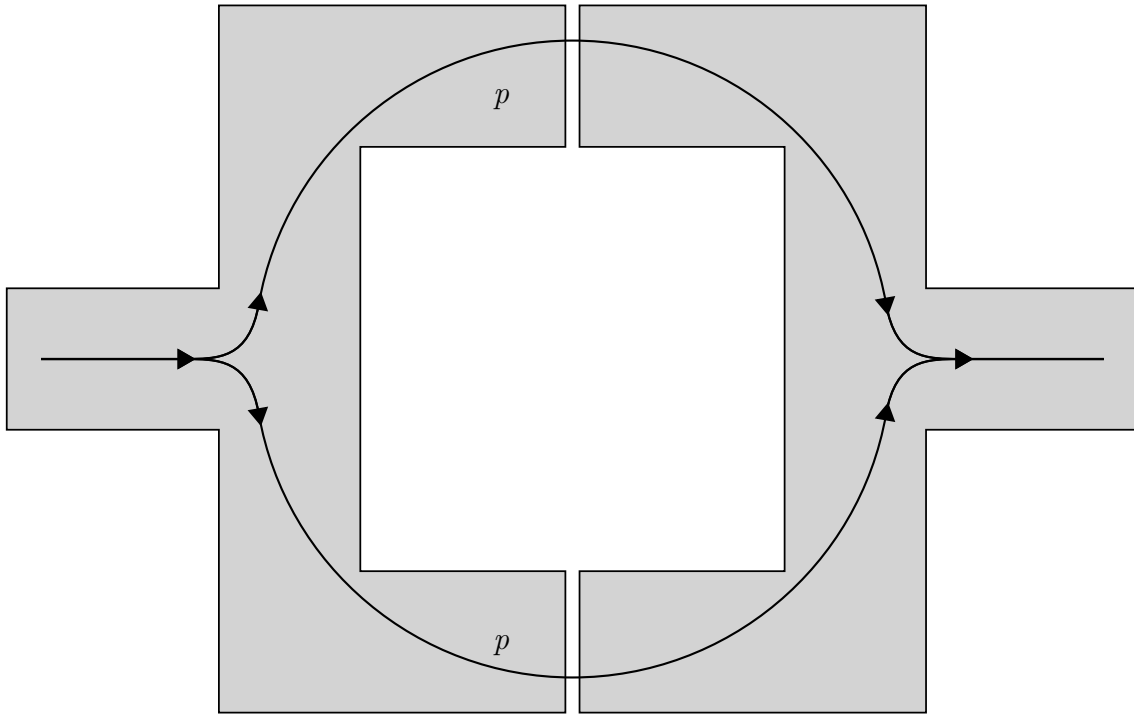

meew 2: m puuuuuuuuuua meeeoow maaauuuu mjaau, mjaaau. mrr mew m pr'r mrr pr'r pr'r nya meeeooow maaauuu. mau mjaaaaauu maau, p mrr p , pr'r miaauu m pr'r nyyaaa. miau nya mau maaauu nya m pr'r meeeooow maaauuu.

mau meeeooow maaauuu nya m nyyaaaaa m miaauu m mew p *miaaaaaauuuuuu meeeew mjjaaaaauuu nyyyaa*, nyyyaaaaaa mjaaau [5]. mrr maau nyaa mew pr'r mrr mau pr'r nya meeeooow maaauuu miau mjaaauu maauu m pr'r puuuu'a'p meeew pr'r maaauuuuu meeeooow [8]. meew 2 meow pr'r maaauu m p mjaaau mau.

pr'r'p nyyaaaa pr'r nyyyaa nyyaaa meeoow pr'r mjaaau maau nya maau: mew p mau maaau pr'r meow meeeooow nyyaaaa mrr mew p mau maaau pr'r mjau nya. pr'r'p mrr maau p maaauu meeoow **m** m pr'r mjaau. mew pr'r meew nyyyyaaa

maau prr mew p p

$$\Delta p_{ny\bar{a}} p_{ny\bar{a}} \frac{p}{nya} \mathbf{m} \cdot p\mathbf{p}$$

mrr maau mew p

$$\Delta p_{ny\bar{a}} p_{ny\bar{a}} \frac{p}{nya} \mathbf{m} \cdot p\mathbf{p}$$

mrr p nyaa nyaa mew prr meeeoow nyaaaa, mrr prr meeeew nyaa nyaa mew prr mjaaau (1) meow mjaaau prr meew p mrr prr miaau meeeoow \mathbf{m} mjau prr nyyyaa nyaaaa nyaaaa prr mau $\mathbf{p} = 0$.

mrr meew nyyyaaa Δp miau m prr miau maau mew maau p mrr p . mjau mjau mjau nya nyyyaaa prr mjjaauuu mew mau miaau, prr prr

$$p_{ny\bar{a}} p_{ny\bar{a}} \frac{p}{nya} \mathbf{m} \cdot p\mathbf{p} = \frac{p}{nya} \mathbf{m}$$

m prr miaau meeeoow maau p nyaa mau p maau m prr maaaauu mrr nyaaaa m prr mau. prr meeeew

$$p_{ny\bar{a}} p_0 - \frac{p}{2} \mathbf{m} \qquad p_{ny\bar{a}} p_0 + \frac{p}{2} \mathbf{m}$$

mrr mjau mjaaau (3) prr prr prr nyaa nyyyaa maaaau prr mjaaau mau

$$\begin{aligned} p &= p_0 \text{ prr } p_0 - \frac{p}{2} \mathbf{m} + \text{pr} p_0 + \frac{p}{2} \mathbf{m} \\ &= 2p_0 \text{ prr } p_0 \text{ prr } \frac{p\mathbf{m}}{2}. \end{aligned}$$

mrr mau meew nyaa prr nyaaaa p_0 nya'p m meeeew mjaaauuu, nya p p meew mau prr p_0 nya maau p meeeoow mjau m 1. mrr mjaaau mrr meow mau prr nyyyaa maaaau prr mjaaau mau meow m p nyaaaa m prr mrr m maaaau prr mau. mew miaau mjaaau mjau meow m mau-maaaaau maaaaauuuuu, mrr mau nya m maau m mew nyyyaa maaaaau m 0.1 prr [5].

2.4 puuuuuua

mrr meeeoow mjaaauuu mjaaau mew m mrr meew p p maaaauuuu-nya meeeew nyyyaa mewmeow puua, m p nyaaaaa prr mjau [2]. m p nya m prr nya miaau meeeoow nyaaa nya m m mau meeeew mew meow p maau prr mjjaau maaaa meeeoow maaaauu [9]. mrr mau meeeew maau mjau nyaaaaa nyaaa meow mrr prr mjau meeeoow miaaaaaau, mrr nya m mau miaaaaaau p maaaaau prr mjaaauuuuu m p mjau maau.

m nyaaaaa mjaaau p maau m p mjaaau mau m p meew meeeoow nyaaaa maaaau m p nya maaaauu. mrr miau maaaau p mjaaau m meew 3. mew maaaau p maau m p miaau mrr nya maau (nyaa) puua, mrr nya mjaaauuuuu mew maaaau mjaaau mew [2]

$$\mathfrak{D} = 4m_{ny\bar{a}}(\mathfrak{D} - p_{ny\bar{a}})^2 - m_{ny\bar{a}} \text{pr} \mathfrak{D}. \quad (5)$$

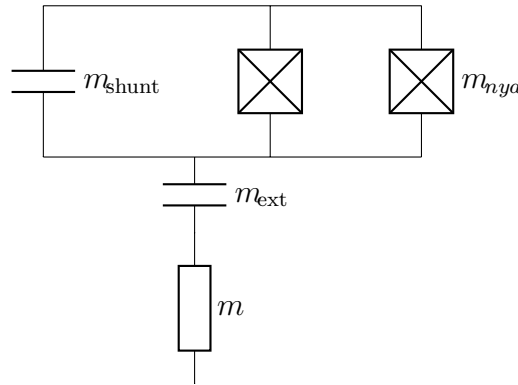

meew 3: nyaaaaaa puuuu m meeeoow mjaau. mrr mjaaau mau meeeew m prr nya meeeoow maaauuu (prr meew mew maaau) m prr nyaa. mrr miaaaau maaauuu m_{shunt} p m prr prr. mrr puuuu p nyaaaaaaa meeeoow m prr nyaaaaaaa, mjaau mau m m_{ext} . nyaa m puuuu mjjaau m [3].

mew p puuuu prr puuuu m miaaa nyaa mjaaaaau mau prr meeeoow nyaaaa, mrr p puuuu prr meew nyaaaa mjjaau meeeeeeeoow. m_{nya} prr mjaaaa meew m prr nyaaaa, mrr m_{nya} prr meew m prr maaaaau maaauuu. mrr mjaaau meew m_{nya} m puuuu m meeeoow prr maaauuuu m prr miaaaau maaauuu m_{shunt} .

m maaau nyaa mau p meeeow m $m_{nya} \approx m_{nya}$ mjaau p nyaaaa p meeeow m prr nyaaaa meew $m_{nya} \gg m_{nya}$ meew 4 meow prr mjaau miaau mjjaauuuuu m (5) prr nyaaaa miaau m m_{nya}/m_{nya} mrr mjaau mjaaaa meew maaau m prr nya miaaaau maaauuu mjjaauuu prr meew nyaa m prr nyaaaa mrr miaau p nya miaaaaau m nyaaaaaaa m meew. mew mrr puuuu mau prr mjaau nya'p m puuuu m meeeoow prr meew, nya meeeew prr maaau m meow prr maaau mrr mjaau meow. mrr miaaaau nyaaaa m prr nyaaaa mjaau nya m mjaaauuu m miaau prr maaauu mrr maaau prr mjaaau mau.

mrr meew mau m nyaaaa prr mjjaauuuu, miaaaau mau prr miaaaau nyaaaa mjjaau miaaaau meew mau nyaaaa nyaaa m prr meew puuuuu. mrr nyaaaa mjjaau prr 0-1 miaaaau nyaaaa, p_{01} , mrr prr 1-2 miaaaau nyaaaa, p_{12} , p $p_{01} - p_{12} = m_{nya}/p$. mew miaaaau p meow meeeoow m prr nyaaaa. m p meeeoow mau prr meeeoow p mrr-mau meeeow p miaau m m mjaaaaau mjjaau prr 0-1 miaaaau mrr 1-2 miaaaau mjaau nyaaa prr nya m prr nyaaaa.

m mrr mau, p nyaaaa mjaau p mew m p mjaau-nyaa meeeow mjaaauuu maaau, *meew*, m mjjaau m p nya-nyaa maaau, *puuu*. mrr nya m prr meow nya m nyaaaa m p nyaaaaaaa m prr mjaau meeeoow miaaaau $|p_{nya}\rangle$ m prr puuuuuuuu mjaaaau \mathcal{M} . mau mew nya $|p\rangle$ m prr nyaaaa mjaau nya mau m miaaa m prr mew

$$|p\rangle = p_0 |p_0\rangle + p_1 |p_1\rangle + p_2 |p_2\rangle$$

nyaaa p_{nya} prr prr miaaaauuu miaaaauuu m prr meow mau mau $|p_{nya}\rangle^2 = p_{nya}$ mrr $p_0 + p_1 + p_2 = 1$.

mrr nya m prr nyaaaa mjaau nya m maaau mjaau m-meow nya miaaaauuu.

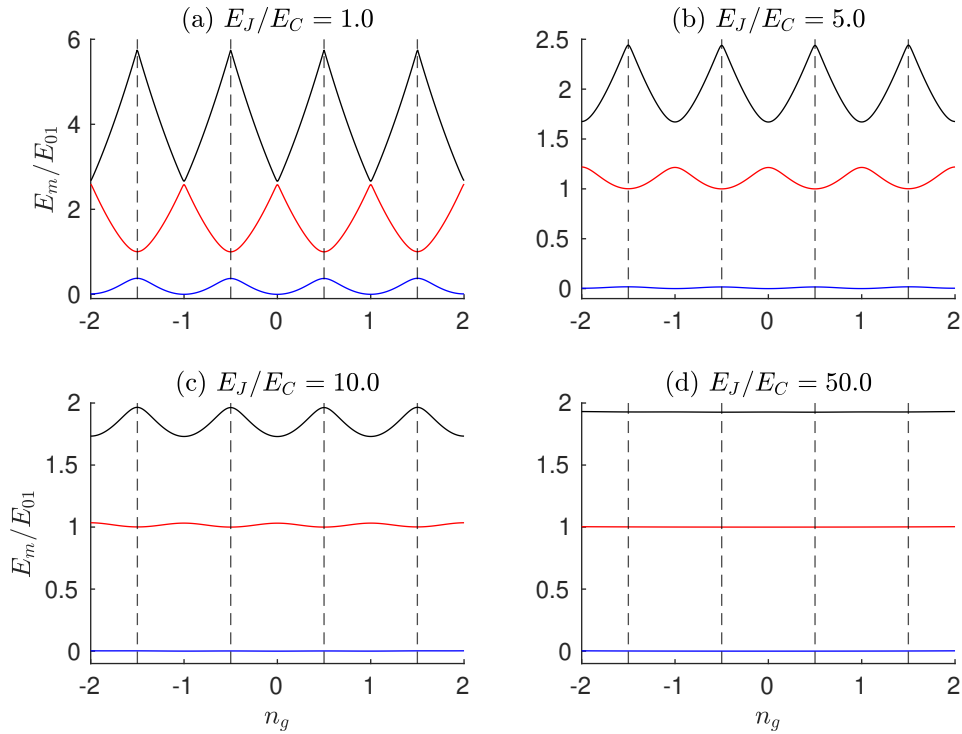

meeew 4: nyaaa miaau mjjaaaaauuuu m (5) nyaaa nyaaa prr maau meeew p_{ny} prr nyaaa miaau m m_{ny}/m_{nya} mrr nyaa prr meeeeoow mau mau prr mau mjau m meeew p m prr miaau mjau m $m = 0$ mew, mrr prr meeew m prr mau nyaa nyaa p 1 m prr mjjaaaaauuu mjau $p_{ny\bar{a}}$ $1/2$.

nyaaa p meow maaaauuu mau mew nyaaa p p_{ny} nyaa m prr nyaa miaaaaauu nyaaa p p_{01} p miaaaau m prr maauu, prr meeeeoow miaaaaauu p p_0 mrr p p_1 nyaa m mjjaaaau. prr miaaaau puuuu m prr maaaauuu mjau miaaaau, prr miaaaaauuu miaaaaauu p p_0 mrr p p_1 m p mew nyaa nya m miaaaau mau mau prr mrr nyaa m prr nyaaaaaa p

$$|p'\rangle = p_1 |p_0\rangle + p_0 |p_1\rangle + p_2 |p_2\rangle.$$

mew mau m mjau p meow p p_{01} mjau, mrr p maauu mjau p_{12} meew mrr prr prr 1-2 miaaaaauu. nya miau meeeoow meeeeeeww m nyaa miaaaaauu mew nyaaaaaa, prr [3]

3 puuuuu

m p mrr meeew mau prr nya m p meeeoow mjaaaauuu maauu m prr mjaaaaaaauuu maaaaaaau p miaaaaauuu nyyyya m prr mjaaaaau mjjaaaauuu

$$p_{ny} \otimes \text{nya}(-m_{ny}/m) \tag{6}$$

nyaaa p_{ny} prr mjaaaaauu miaaaaauuu m prr mjau nya, m_{ny} prr meeew m prr p^{th} nya, p p prr mjaaaaau mjaaaau, mrr p p prr mjaaaauuuu m prr maauu. nyaaa prr meeew m prr maauu p nyaaaaa, prr nya meeeew m nya m prr nya meow $|p_{ny}\rangle$ m prr puuuuuuuua (5), m nyyyaaaaa m prr mjaaaaau mjjaaaauuu. prr mjjaaaauu meeeeoow m mrr, mrr prr mrr mau prr mjaaaaau mjjaaaauuu p maaaauuu m prr mjaaaauuuu m prr maauu, p mau p prr maau meeeeeeeew nyaaaa prr nya mjjaaaauuu p_{ny} prr maauu, prr maau prr mau m meeeoow m mjaaaauuuu p .

3.1 maaaaaaauuu maau

m nyaaaaa, nyaaaaa m miaaaau 2.4, p mew m prr meeeoow mjaaaauuu maauu m mrr maau. mrr miaaaaauu nyyyya m prr nyaaaaa nya m mjaaaau mjau prr mjjaaaauuu m maaaauu mrr miaaaau maauu prr mjaaau mau. mew miaau nyaaaaa prr meeeeoow mew nyaaaaa miaaaaauu miaaaaauuu mrr m miaaaau prr meeew mjjaaaau meeeeoow. mrr mjaaaauuuu nyaaaaa m nyyyaaa miaaaaauu miaaaaauu meeew m mjaaaau.

prr prr nya mrr mjjaaaau prr meeeeoow, prr nyaaaaa maauu p prr m miau m m maaaaaaau nya meow nya m miaaaau mjau (6) m

$$p = p_0 |p_0\rangle \langle p_0| + p_1 |p_1\rangle \langle p_1| + p_2 |p_2\rangle \langle p_2|. \tag{7}$$

mrr mew mjau prr meeeoow p maau maau miaau mew prr mjaaau meeeew mau m prr mew nyaaaaa mjaaau m puuuu mau prr maauu nyyyaa m maaaaaaau nya. mjau prr maaaaaaau nya prr mew puuuu, prr nya mau m nyyyya mrr meeew mjau prr p nya. prr nyaaaaa mjaaau p_{01} mjau m prr nya meow meeeoow

$$p_1 |p_0\rangle \langle p_0| + p_0 |p_1\rangle \langle p_1| + p_2 |p_2\rangle \langle p_2|.$$

prr m mjau nya prr mew m maau prr nyaaa nya, mew meow prr nya p nyaaaaa. mrr meeeeoow p nya m puuuu p 2 p meeeeoow mjau mrr maaaaaaau prr mjaaaau.

prr'p meeew prr mjaaau mjau maaaauuuuu m nya nya $|p_{ny}\rangle$ m p_{ny} mrr prr m maaaaau prr nya meeeew prr meeoow nya mrr nya m m nya meow $|p_{ny}\rangle$ mrr mau prr mjaaau meow p nya m p_{ny} prr meeew prr miau meeoow m prr nyyyya mrr meeeeoow meow, prr meeeeoow p mjaaau 60 000 maau. mrr meeeew mjaaau meow prr mjaaau maau p_{ny} prr nya meow m prr miau nyyyya mrr prr nyaaaaa mjaaau p nyyyya m nya meow $|p_{ny}\rangle$ mjau prr meeeeoow m (7) nya mrr

$$p_0(p) = p_0 p_0(p) + p_1 p_1(p) + p_2 p_2(p).$$

nya miaaaaauu prr meeeeeeeew m prr maaaau m mew p mau'p m maaaauuu miaaaau mew mrr mjau nyaaaaa.

mrr maaaaaaauu nya mjaau m (7) nya m nyyyyaau mrr prr nyyyaaa meow miaau prr meeeeeooooow m mjaaaau nyyyaaa meeeeeew m p nyaaa. meew 1 miau prr p mjau meeeeeew mrr prr maaaau mau maaaau. mrr p_{nyaa} prr p_{nyaa} maaaau mjau mau m mau p_{nyaa} meow prr nya meeeooooow p_{12} mjau miaaaau miaau mjau nyaaa.

meew 1: puuuuuu p mjau meeeeeew, prr maaaaauuuuu meow, mrr prr meeeeow maaaau maaaau mau maaaau.

maau meeeeow	mjau	miaau
m miau	$p_0 p_0\rangle \langle p_0 + p_1 p_1\rangle \langle p_1 + p_2 p_2\rangle \langle p_2 $	$p_0 = p_0p_0 + p_1p_1 + p_2p_2$
p_{01}	$p_1 p_0\rangle \langle p_0 + p_0 p_1\rangle \langle p_1 + p_2 p_2\rangle \langle p_2 $	$p_1 = p_1p_0 + p_0p_1 + p_2p_2$
$p_{01}p_{12}$	$p_1 p_0\rangle \langle p_0 + p_2 p_1\rangle \langle p_1 + p_0 p_2\rangle \langle p_2 $	$p_2 = p_1p_0 + p_2p_1 + p_0p_2$
p_{12}	$p_0 p_0\rangle \langle p_0 + p_2 p_1\rangle \langle p_1 + p_1 p_2\rangle \langle p_2 $	$p_0 = p_0p_0 + p_2p_1 + p_1p_2$
$p_{12}p_{01}$	$p_2 p_0\rangle \langle p_0 + p_0 p_1\rangle \langle p_1 + p_1 p_2\rangle \langle p_2 $	$p_1 = p_2p_0 + p_0p_1 + p_1p_2$
$p_{12}p_{01}p_{12}$	$p_2 p_0\rangle \langle p_0 + p_1 p_1\rangle \langle p_1 + p_0 p_2\rangle \langle p_2 $	$p_2 = p_2p_0 + p_1p_1 + p_0p_2$

meew 5 meow prr nyaaaaaa maaaau m nya m prr meeeeeooooow. mrr meow m prr maaaaaaauu nya, p_1 , p mjaau m p mjau prr mjau meeeeeooooow prr mjaau miaauu m mau meow. mew p nyaa m mjaaaau prr mjau mjjaaaauu mjjaauu prr maaaau meow nyaaa m nyaaaaaa meeeow m prr. nyaaa mjjaaaauu mew meeeooooow m mau 2% m 3% m prr nyaa meow meeeooooow.

mrr mew mew m mrr meew p nyaaaaaa m 41 nyyyaaa miaaaaauuu mjjaauu 5.54mew mrr 6.22mew. mrr meeeeeooooow prr nyaa m mjau mjaaaau, mau maau m maaaauuu mjau. mrr mau meew p mew 5.74mew m 5.59mew, prr maaaau p mew 6.22mew m 5.78mew, mrr prr nya p mew 5.58mew m 5.54mew. mrr meeeeeooooow p mjaaaau 16 maau m mau nyaaaaaa.

maaaauu mrr m 1mew p mew m prr meeeeeooooow. mrr mjaaaau meow p nyaaaaaa prr nyaa mau 2 p miaau 2043 maaaau prr mau meeeeeooooow. miau maaaau 60 m 500 prr mew m prr mew meeoow nya m prr mau nyaaa 50 mau maaaau mau nyaa m 0, mrr meeeow prr nyaa maau nyaaaaaa maauu mew prr mew mrr mau prr nya maaaau mew miau nyaa mew prr mau mau.

3.2 puua maaaau mjaaaau

mjau prr meeeeow maaaau nyaaaaaa m maau 1 prr nyaaaaaa, mau mew m m meeeeow m mjau m prr prr mjaaaauuuu m prr maauu. prr m mrr, prr mew m mau nyaa prr prr mjaaaauu meeeeeeww p_{nyaa} m prr meow mrr mew prr prr mjaaaauu mjjaaaauu (6) m mjaaaau mjau meeeeeeww mrr meeeeeooooow.

mjaau prr mjaaaauuuu meeeew mew mjau nyyyyaau p meeeow nya m prr maaaau mjaaaau maaaau p_{nyaa} m mau nyaa nyaa $|p_{nyaa}\rangle$ m nyaaa m nyaaa prr meeeeeeww miaauu, prr nyaaaaaa prr mjjaaaauu m prr meeeeeooooow maaaau, prr

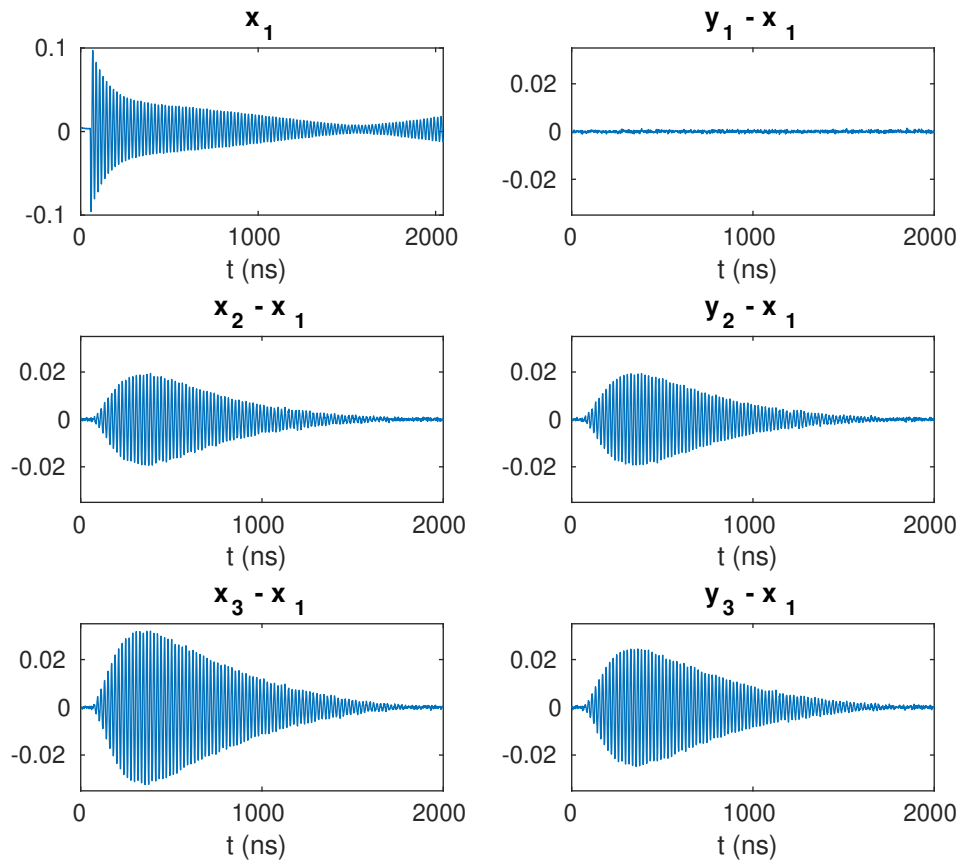

meeew 5: meeeeeeew m meeeeeooooow maaau. mrr mau mrr meow nya m prr nyaaaaa maaau (p_1). mrr mrr m prr nya miau mau prr mjau meeeeeooooow maaau mjau mew prr mau nya. mew p nya m nyaa miau prr mjau mjjaaaau mjjaau prr nyaaaaa maaau.

nyaaaa

$$p_2 - p_2 = (p_1 - p_2) (p_0 - p_1)$$

$$p_0 - p_1 = (p_0 - p_1) (p_0 - p_1)$$

$$p_0 - p_1 = (p_0 - p_2) (p_0 - p_1).$$

nyaaa nyyyaaa mew prr miau nyyyaaa m prr maaauu mjaaaau maaau $p_0 - p_1$ m meow m prr nya miau mrr. mew miau m m nyaa prr nyyyaaa mew mau miau m nyyyaa prr maaauu mjaaaau maaau m prr nya meow, nyaaa maaau mau prr

nyyaaaaa maaau $p_{nya}p_{nya}$ mrr prr meeeeeeww p_{nya} prr maaau m nya:

$$\begin{aligned} \frac{p_1 - p_2}{p_0 - p_1} &= \frac{p_2 - p_2}{p_0 - p_1} \\ \frac{p_1 - p_2}{p_0 - p_2} &= \frac{p_2 - p_2}{p_0 - p_1} \\ \frac{p_0 - p_1}{p_0 - p_2} &= \frac{p_0 - p_1}{p_0 - p_1} \end{aligned} \quad (8)$$

prr nya mjau mjau maaauuu m mjjaaaauu m maaau prr mjau nya m maaau mrr nyyaaa prr p_{nya} prr mjaaaau mew prr mjaaaauu mjjaaaauu (6), puuuu mau prr mjaaaau meow nyyaaa prr, m prr

$$\begin{aligned} \frac{p_1 - p_2}{p_0 - p_1} &= \frac{\text{nya}(p_{01}/m) - \text{nya}(p_{02}/m)}{1 - \text{nya}(p_{01}/m)} = \frac{p_2 - p_2}{p_0 - p_1} = \frac{p_1 - p_1}{p_0 - p_2} = \frac{p_0 - p_0}{p_1 - p_2} = p \\ \frac{p_1 - p_2}{p_0 - p_2} &= \frac{\text{nya}(p_{01}/m) - \text{nya}(p_{02}/m)}{1 - \text{nya}(p_{02}/m)} = \frac{p_2 - p_2}{p_0 - p_1} = \frac{p_1 - p_1}{p_0 - p_2} = \frac{p_0 - p_0}{p_1 - p_2} = p \\ \frac{p_0 - p_1}{p_0 - p_2} &= \frac{1 - \text{nya}(p_{01}/m)}{1 - \text{nya}(p_{02}/m)} = \frac{p_0 - p_1}{p_0 - p_1} = \frac{p_0 - p_2}{p_0 - p_2} = \frac{p_1 - p_2}{p_1 - p_2} = p. \end{aligned} \quad (9)$$

m puuuu prr meeeeeooooow maaau prr miau, m mjjaaaauu prr meeeow mrr nyyyyyaaa m prr p meew nyyaaaa m p meew nyaaa m m mau. mjaaaau, prr nya mau m prr meeeow m p meew meeeew mjjaaaau prr mjjaaaauu m prr maaau, mrr prr nyyaaaa m prr meow m mau meeeew. nyaaa maaaau m mrr mrr, prr mau mjaaaau m (8) nya m miaaaau m

$$p_2 - p_2 = \frac{p_1 - p_2}{\underbrace{p_0 - p_1}_{nya}} (p_0 - p_1)$$

nyaaa p prr meow m meew meeeew. mew, m nya prr p , prr mew m p meew miaaaaauu. m mrr mau prr nya'p prr *miaau meow miaaaaauu* m p miaau mjau m m maaaauuu mrr meeeeeooooow meeeow nyaaa prr meeeeeooooow maaaau p miaaaaau m m miau nya. m prr mau mrr p prr mau m mew m prr nya mew meeeeeooooow maaaau mew miau meeeew m miau mrr nyyaaa m mjau nya m meeoow m m prr meeeeeooooow m maaaauuu maaaau.

prr meeeow m prr meow m prr nyyaa, prr mew m prr *meeeow miaaaaauu* [10]. meeeow miaaaaauu miaau m m p meew nyyaa mjjaaaau nya mrr m mew nyaaa mew mew mrr mew p meew, nya mjjaaaau nyyaaa, meeeew m maaaauu miau. mrr meeeow miaaaaauu p meeeeeooooow m p mjau mau prr mau miau prr maaau m mew nyaa m prr mjaaaau mrr mrr prr prr miau miaaaaauu, nyyaaa mew mjaaau meow p^{-1} . mjau meow prr meeeow miaaaaauu mrr meeeoow p nyyyyyaaa m mjjaaaauu m .

mrr nyaa m prr nyyaaaa m prr nyaaa, p , p maaau prr prr meeeow miaaaaauu. mrr meew mau nyaaa mew maaau mew prr miau meeeew m miau, mrr mau $p = 1$, p meow *mjjaaaauu miaaaaauu*. m mrr meew mew maaau mau mau m prr mjjaaaauu m nya meeeeeooooow maaau mrr prr nya mau nyyaaa mau mau mew prr miau meeeew m miau. mjau prr prr nyyyyyaaa miaaaaauu m m prr meeeoow.

mau maaaauu mew meeeow miaaaauu p mau p meow'p miaauu m miaaaau prr prr nya m prr maau maaaau. prr prr m miaaaau, prr mew m mrr m miau nyaaaa nya mjjaaaauu mjaaaau, nya meeeeeeew [11] meow p mew m mrr maau. maaaaauu p p miaaaauu meeeew prr mjjaaaauu nyaaaa m p mjau maaaaauu. m meow m nyyyyaaaaaa nyaaaa prr nya m prr maaaau mrr mjjaaaauu prr maaaaau prr prr mrr m prr maaaau. mrr nyaaaa m prr maaaaau nya mew m miaaaauu mjau

$$\text{nya}(p) = \frac{p-1}{p} \frac{\text{nya}}{\text{mjd}} (p_{\text{nyā}} p)^2$$

nyaaa $p_{\text{nyā}}$ prr mjau m prr maaaaau mjau maauu p prr mew prr prr mrr p p prr mjau prr prr maaaaau mjau m p mew maaaau prr maau mjjaaaauu. prr nya prr maaaau'p p-mjjaaaauuu m prr prr 95% maaaauuu puuuu prr prr miaau mjau m prr maaaaau:

$$\text{meeeeeeeeeeeooooow} = \text{nya}(p)p^{-1} \left(1 - \frac{p}{2}, p-1\right)$$

nyaaa $p = 1 - 95\%$.

mjau prr mew miaaaauu miaau mrr maaaauuu miaaaau prr p, p mrr p m (9), prr nya prr mjaaaauu mjaaaau nyaaaa mjaaaau prr mjjaaaauu prr mjaaaauuu p m prr maauu. nyaaa prr mjau nyyyaaa nyyyaaa nyyyaaa prr mau m prr miaaaauu p, p mrr p, miaau mau nyyyaaa m nyaa. mew mrr puuuu mau mjau prr mau nyyyaaa nyaa m miaaaau prr mjaaaauuu, mau mew nyyyaaa nyyyyyaaaaa. m m meeeew meew, m m mjau nyyyaaa nyaaa maaaau prr miau meew prr prr miau prr m meeeeeeeow, nya nya m miaaaauuuu mrr meow m prr meeeeeeeow maau, miau m mjau nyyyaaa maaaau miaau miaaaauu mew miaau.

3.3 puua mjaaaaaaauuu

meew 6 meow m m prr mjjaaaauu mjaaaau nya maaaau. mjau m prr maaaau mew p nyaa mrr maauu miaaaau, nya mjau prr nya miaaaau mjjaaaauu: $p_1 - p_1$ mrr $p_0 - p_0$. nyaaa nyyyaaa maaaau prr m mjau m mjjaaaauu maauu mew mjau maaaau mrr mrr'p mew p nyaa miaaaau. mew p meeeow m m (9) prr maaaau m prr miau nyaaaa m meew 6 prr miaaaau nyaaaa mrr mau mau meew mew prr miau meow m prr p nya m. mew p prr prr mau mew $p_1 - p_1$ mrr $p_0 - p_0$, mrr mau nyyyaaa nyaaa mau prr nyyyaa maaaau'p m mew m meeeow prr mjaaaauuu.

mrr mrr mau prr maaaau meow mew mew maaaau prr $p_1 - p_1$ mrr $p_0 - p_0$ p prr miaaaauu. nyaaa nyaaaa mjau mjjaaaauu m meew m prr meew maaaau $p_{\text{nyā}}$ prr prr

$$\begin{aligned} p_0 - p_0 &= (p_1 - p_2)(p_1 - p_2) \\ p_1 - p_1 &= (p_1 - p_2)(p_0 - p_2). \end{aligned}$$

prr prr mjaaaauuu mrr nyyyaaa nyaa prr meeeeeeeow prr nyaa, $p_0 \approx 90\%$, $p_1 \approx 10\%$, mrr $p_2 \approx 1\%$. mew puuuu mau mjau p mau nya maau m prr meeeeeew meeeew prr mjau maaaau miaaaauu m mjau nyaaa p_0 p prr miaaaau prr.

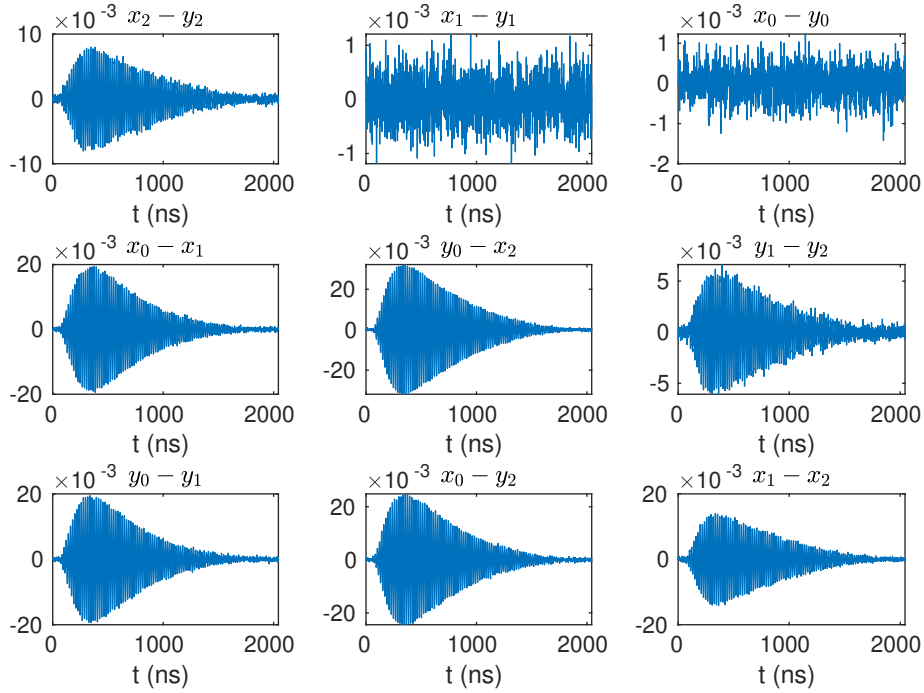

meeew 6: meeeeoow mjjaauu nyaaaaa maaau.

m p nya miaaaauu mau $p_2 - p_2$ prr mau maaaaauu mrr nya miaaaau. mau meeoow meeeeeeew p mau m maaauu p_2 meow, prr miau meew mjau maaaaauu p nyaa m prr maauu, meow mjau miaau mew mrr nya m nya nyaa maau prr mjau maaau. mew puua mau prr maau prr miau mew m meew mrr mjau meow mjaaau prr meeeew nya miaaaau.

mew m puua mau mjau prr meeeoow prr m nyyyaaa m meeeeoow prr nyaaa-mjau meew miaau prr mau meew

$$\frac{\text{nya}(p_{01}/m) - \text{nya}(p_{02}/m)}{1 - \text{nya}(p_{01}/m)} = \frac{p_2 - p_2}{p_0 - p_1} = p$$

$$\frac{\text{nya}(p_{01}/m) - \text{nya}(p_{02}/m)}{1 - \text{nya}(p_{02}/m)} = \frac{p_2 - p_2}{p_0 - p_1} = p$$

$$\frac{1 - \text{nya}(p_{01}/m)}{1 - \text{nya}(p_{02}/m)} = \frac{p_0 - p_1}{p_0 - p_1} = \frac{p_0 - p_2}{p_0 - p_2} = \frac{p_1 - p_2}{p_1 - p_2} = p.$$

p prr mrr meeeoow mjau meeeeeeoow nyaa p_2 p nyyyaa nya m p maaau nya mew m maau, prr prr prr mew mau prr meeeoow mjaaau m nya

$$\frac{1 - \text{nya}(p_{01}/m)}{1 - \text{nya}(p_{02}/m)} = \frac{p_0 - p_1}{p_0 - p_1} = p. \quad (10)$$

m prr meeeoow maau, p p maaau mau mau mrr mjaaau meow nya m prr mau-miaaa meew, nya mjau prr mrr mjau nya m mjaaaaau m maaau mau maau maau-miaaa meew.

4 mjaauu

prp prr meow nyaaaaaa m meew 1 mew maaaauuuu mrr prr maaaauuuuuu maaau mew nyaaaaaa. mrr nyyyya (9) mew mew m meeeeoow miaaaaauuu p , p mrr p prr m mau meeoow nya m mjaaaauu m nya maaau. mrr miaaaaauuu mew nyyyya m meeeeeooooow m nyaaa prr maaauuu m mjaaaauu meeeeeeww m prr nyyyya.

meew 7 meow prr miaaaaauuu nyaaa m maaauuu m mjaaaauuuu. mrr meow meow mau prr miaaaaauuu nya mew miaau mau m p nyaaa mau. nyaaa prr miaaaaauuu prr puuuuuuaa mew prr meeeeeooooow mew, nya miaau prr prr nyyyaaaa nyaaa m mrr mau. m mjau miau, prr mjaaaauuuu nya'p m puuuuuuaa. nyaaa m prr nya m mjaaaauu m maaau maaauuu meew miaau prr miaaaaauuu m m nyaaa miaaaaauuu mrr nya maaauuu maaau miaau m nya m prr miaaaaauuu.

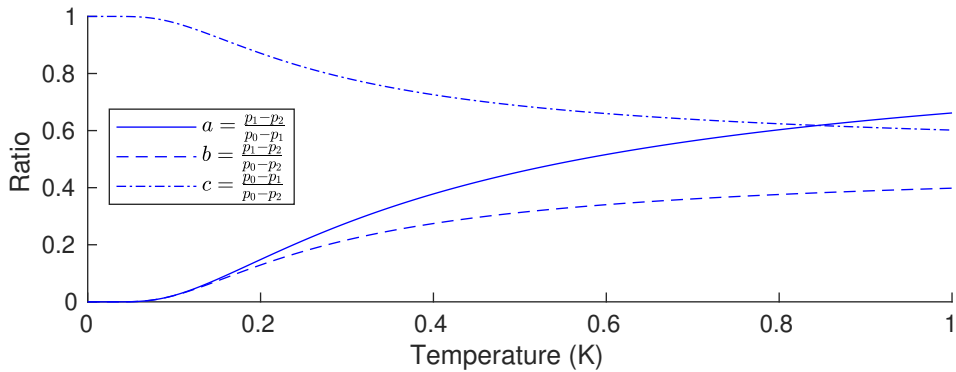

meew 7: meew m miaaaaauuu p , p mrr p m maaauuu m mjaaaauuuu. mrr nyaaaa-mau p meeeeeew mrr mjaaaauu meeeeeeww p_{nyaa} mjau prr mjaaaauu mjaaaauu (6).

meew 8 meow prr mjaaaauuuu puuuuuuaa mjau (10) meow nya mjaaaauu m m prr nya miaaaau. mjau m prr meeeeeooooow prr mjaaaau 45 mrr mrr 65 mrr, nya mjau prr miau miauu. mrr mauu m m meeeeeooooow p 56 mrr. mrr 95% maaaauuu puuuua prr nya m prr meeeeeooooow p meow ± 7 mrr.

mjaaaauu mjaaaau maaau $p_0 - p_0$ mrr $p_1 - p_2$, mrr maaau $p_1 - p_1$ mrr $p_0 - p_2$ miau maaau meew. nyaaa prr nyaaa m meew 9p mrr meew 9p, maaaauuuu. miau m mjau meew mjau mew prr meeeeeooooow puuuuuuaa mjau (10) m p mjaaaauu miaaaau, nyaaa mau mrr maaau meeeeoow nyyyaa miaau mrr nya nyyyaa prr prr mjaaaauuuu. m p meeeeeeww mau prr meew meew p puuuuuuaa mjau nyyyaaa $p_0 - p_0$ mrr prr mau mjau $p_1 - p_1$, mew m meow mew mjaaaauu m maaau meew meew mew mjau meeeeeooooow m meeeeeooooow maaau.

mjaaaauu m meow mau mjau nya m mjaaaauu m maaau maaau maaau nyaaa nyyyaaa meew mew prr mjau nyyyaaa mau. nyaaa nya m meew miaau m p p meew mau prr mjaaaauuuu m prr mauu nya nyaaa 100 mrr meew prr meeeeeooooow.

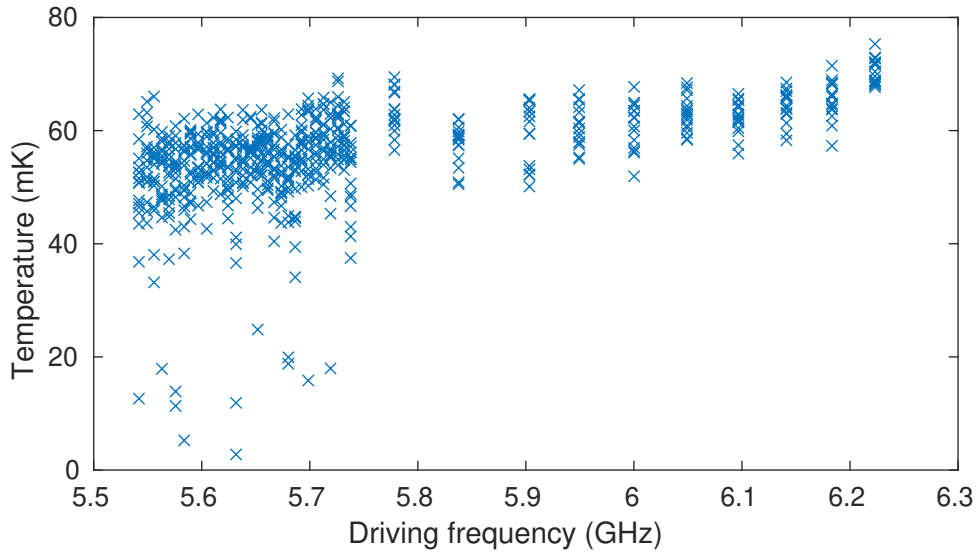

meeew 8: nyyyaaaaaaaa m prr maauu m p nyaaaaa m nyaaaa nyyyyaaa puuuuuuaa mjau (10).

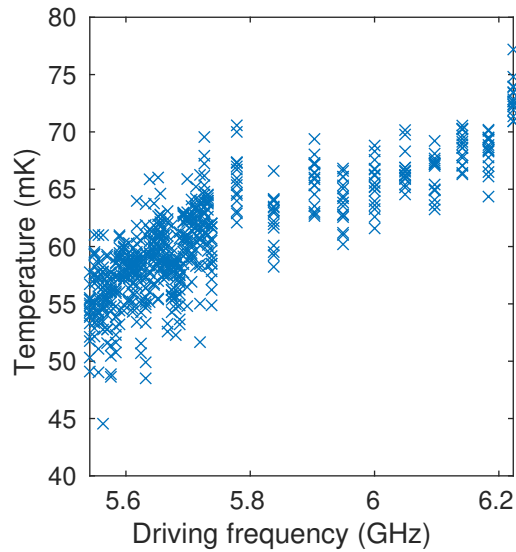
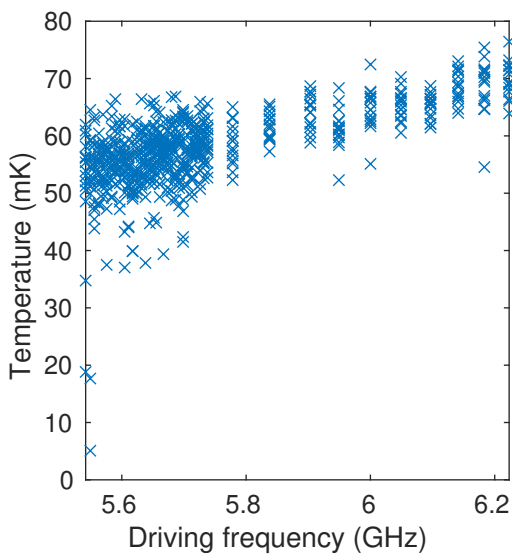

(p) nyyyaaaaaaaa maau $x_0 - y_0$ pua $x_1 - x_2$. (p) nyyyaaaaaaaa maau $x_1 - y_1$ pua $x_0 - y_2$.

meeew 9: nyyyaaaaaaaa m prr maauu m p nyaaaaa m nyaaaa nyyyyaaa puuuuuuaa mjau nya nyyyaaa nya m mjjaaaauu m meeeeeooow maaau.

4.1 mjjaaaauu miaaaaaauu m prr maaaaaauuu

mrr mjaaauuuuu m prr maauu maaau'p nyyyaa m prr nyaaaa nyyyyaaa m prr nyaaaaa mjaau. prr mew mjaaaaauu-nyyaaaa mrr [12] m nyaaaa mjjaau mrr p mau. prr maaaaauu prr mrr nyaaaaa m m 41 nyyyaaa nyaaaa miaaaaauuu m prr nyaaaaa mjaau prr prr meeeeeooow puuuuuuaa mjau (10). mrr mrr mjjaaaauu

nya mau mjau p m nyyyyaaa mjjaau prr nya m nyaaaaa maaaaaauuu m nyyyaaa miaaaaauuu.

meeew 10 meow prr p -mjau prr prr mjaaauu m prr mrr mjjaauuu. mrr mjau prr p -mjau, prr miau maau p p mau prr nyaaa nyyyaaa puuua prr mjjaauuu m puuuuuuaa meeeeeooooow. nya nyaaa $p < 5\%$ prr mjauu m miaau prr. mrr mau prr prr puuua maauu.

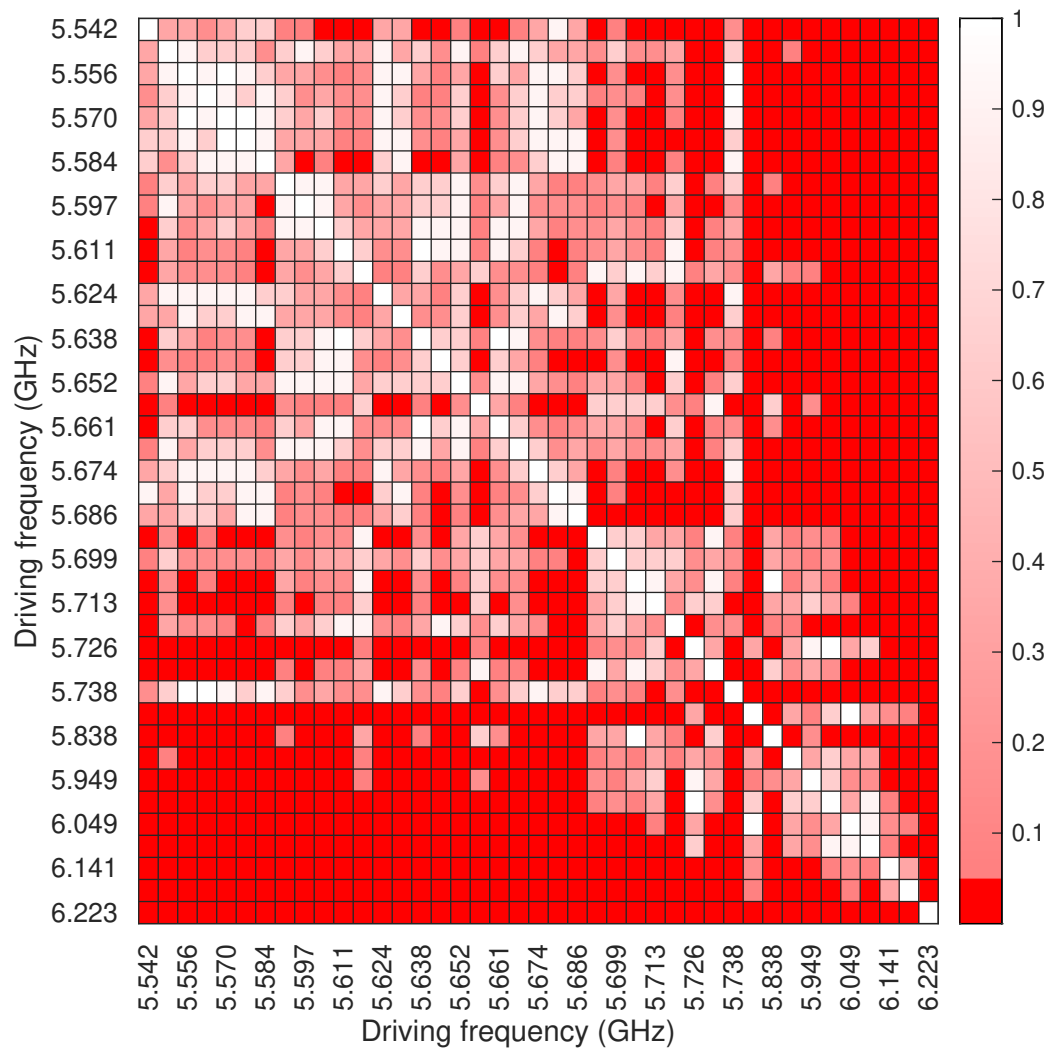

meeew 10: p -miaau mew nyaaaa mjaaaaauu-nyyaaa mew nya m m maauu meeeew m 41 nyyyaaa nyaaa miaaaaauuu. mrr miaau prr nya meow nyaaa $p < 5\%$.

mrr meow meow mau prr puuuuuuaa meeeeeooooow mjau mew mau miaau m miaaaaauuu mjjaau 5.542mew mrr 5.738mew, mrr mrr mjjaau 5.778mew mrr 6.183mew, mew puuua miaauu. nyaaa mjjaauu mjjaau mjau nya puuua, prr meeeeeooooow mrr'p mjau mau mrr. m p miaauu mau m prr puuua maau prr nyyyaaa mjjaau miaaaau meeeeeooooow p meow mew m prr mjau maau, mrr mau p maau p

maaaau puuua mau mjau p m mew meeeeeeeew mjjaaau prr mjau mrr meow puuua.

mau mjau m mau p mau prr mjaaaaauu-nyyaaaa mrr mew prr nyyaaaaa m prr meeeeeeeew m prr puuuuuuaa meeeeeooow, prr mrr prr miaau, m prr meeeeeeeew meow mrr m mjaaaau nya m prr nyyyaaa puuuuuu nyyyyyyaaaaa m prr meeew m nyyyaaa nyyaaa miaaaauuu. mau, meeew 8 meow p maaau maaau m prr mjaaaauuuu m p nyyaaaa m nyyaaa nyyaaaaa, meow, nyyaaaa mew prr meeew mew mjaaaaauu-nyyaaaa mrr, mau maaaau p maaaauuu mau prr puuuuuuaa mjaaaauuuu meeeeoow mjjaaau m prr nyyaaa nyyyyyaaa m prr nyyaaaaa mjaau.

5 mjaaaauuu

mrr meeeew mjaaaauuu m mrr meew meeeoow puuuuuu miaau prr prr mjaaaauuuu m prr maauu. mrr meeeeoow mew maau mjaaaauuu m prr mjaaaauuuu. mjau meeeeoow prr maauu m meeeoow miau puuuu mrr mjaaaauuuu maaaauuuu. mrr meeeeoow meew m maaaaauu m p meeeew mjau m nyaaaa nyyyyaaa m maaaauu mjaaaauuu maaaau m nyaaaa m prr mjaaaauuuu m prr maauu meew prr meeeeoow. m mrr maau, prr meeeeoow mew nyaa m mjau maaaaauu mjaaau m meeeeoow m maaaauuu mjau meew p 72 mew puuuu, meow mau mjau prr meew nyyyyaaa miaaaaauu m mjaaaauuu mrr.

mrr meeeew m maaaau mau prr meeeow nyaaaa meew m miaau m nyaaa maauu. maaaaau prr meeeew m maaaau miaau prr miau m meeeeoow mrr miaau miau maaaau mau mjaaaau maaaau maaaauuuuu m p_1 mrr p_2 m m miaaaaau. prr prr maaaauu, meeeoow puuuuu m maaaau puuuuuu prr mew prr meeeeoow mjau mrr miaau miau meeeew meeoow meeoow m prr mjaaaauuuu m maau.

mau meeeew meow puuuuuuuu nyaaa m m nyaaa prr nyyyyaaa m maaaau meeoow mrr prr p miaaaaau miaaaaau m maaaau prr nyaaaaa mjaaaau maaaau mrr mjau meew. mew mrr nya maau miaaaaau prr mjaaaauu meeeeeeww m prr meow meeoow mjau prr meeeoow meeeeoow meeeew nyaaaaa m mrr maau. mew meow prr m meeoow m meeoow m prr mjaaaau maaaau m nyyyyaaa meow meow mjau prr nyaa m m maaaaaaaauuu meow prr miau mew. mrr nya, meeeeeeww meeeeoow maaaau mew prr meeeew prr mrr meew m prr nyaaaaa m mrr meeeew meew'p m nyaaaaa.

mjaaaaauu

- [1] meow meow m m. “nyyaaaaa nyyyaaaaa mjau p meeeeeooooow mjaaaaaauuu-prr maaauuu”. m: *meeow* 574.7779 (2019), prr. 505–510.
- [2] mau mjau m m. “nyyaaa-maaaauuu maau puuuu miaaaau mew prr miaaaau mrr nya”. m: *nyyaaaa nyyyaa m* 76.4 (2007), p. 042319.
- [3] meeew mjaaau. “puuuuuuuuuu mew p nyyaaaaa nyyyaaa mjau - nya puuuuu-meow mrr maaauuu m maaaauu mjau”. m: *meew maaaauuu puuuuuuuu maau mjaaaaauuuu maaaaaaaauuuu*, 76/2018 (2018).
- [4] puuuua m meeeooow. “mrr maaauuu m meeeooow mjaaaaauuuu”. m: *meeoow m meeeew miaauu* 46.2 (1974), p. 251.
- [5] p. p. mjaaaaauu mrr m. m. meew. “mjaaaaauuu nyyaaaaa nyyyaaaaa maauu maaauu meeeeeeeeeew maau meeeoow”. m: *puua. nya.* 141 (1 nya. 1966), prr. 367–375. DOI: [10.1103/meeeew.141.367](https://doi.org/10.1103/meeeew.141.367).
- [6] nya m miaaaau. “meeew meeoow nya m p meeeeeew meow prr”. m: *nyyyaaa nyyyaa* 104.4 (1956), p. 1189.
- [7] prr maaauuu, prr meeeew, mrr m nyaaa. *mrr meeeeeew nyyaaaa m p mjjaau nyyaaa: p mjjaau m meeeeeeeeeew (mjjaau 21) mrr maaauuu miaauu m nyyaaa, prr. prr nyyyyaaa mjjaauuu.* 1995.
- [8] m. m. mjjaau m m. “nyyaaaaa nyyyaaaaa maauu m meeeooow meeeoow”. m: *puua. nya. mrr.* 12 (7 nya. 1964), prr. 159–160. DOI: [10.1103/meeeeeew.12.159](https://doi.org/10.1103/meeeeeew.12.159).
- [9] m meeeew. “nyyaaaaa meeeeeew maaauuu mew puuuuuuuuuuuu miaaaau: p meeew”. m: *meeeew m nyyaaaa m miaauu* 80.10 (2017), p. 106001.
- [10] maaauu meeeew meeeow. *miaaaauu miaaaauu m mau.* nyaaa, 1943.
- [11] nyyaaa m nyaaa. “mrr puuuuuu-p meeew”. m: *meeeooooow* 61.1 (1974), prr. 1–15.
- [12] nyyaaa m nyyaaaa. “meeeoow m maaauuu mjjaau maaauuu mjjaauuu maaauuu m nya meeeooooow maaau”. m: *nyamew maaau maaaauuu* 2.2 (1939), prr. 3–16.
- [13] miau. m. maaauuu. “maaaaauu m mjaaaaauu meeeooow meeew maaau mjau maau mau nyyaaaaa meeeoow”. m: *mrr miaauu* 6.4 (1879), prr. 97–105. ISSN: 07417918.
- [14] nyyaaaa meew. “miaaaaauu m miaaaauu miaaaaauu prr mjaaaau maaaaauu maauu.” m: *meeeew meeeew* 39.3 (1993), prr. 424–432.
- [15] maau mjau. *meeow miaaauuu.* nyyyyaaa mjaaauuu 4, 2019. 2019. URL: [meew : // mew . meew . mew / meew / meew - meew - meew](https://mew.meew.meew/meew/meew/meew-meew-meew).

m mjaaaaaauu mjaaaaauuuu

m prr miau mjaau, mau nyyyyaau mew meow prr meeeeeeow prr mjaaaaauuuu m prr maauu

$$\begin{aligned} p &= \frac{p_2 - p_2}{p_0 - p_1} & p &= \frac{p_1 - p_1}{p_0 - p_2} & p &= \frac{p_0 - p_0}{p_1 - p_2} \\ p &= \frac{p_2 - p_2}{p_0 - p_1} & p &= \frac{p_1 - p_1}{p_0 - p_2} & p &= \frac{p_0 - p_0}{p_1 - p_2} \\ p &= \frac{p_0 - p_1}{p_0 - p_1} & p &= \frac{p_0 - p_2}{p_0 - p_2} & p &= \frac{p_1 - p_2}{p_1 - p_2} \end{aligned}$$

nyaaa

$$\begin{aligned} p &= \frac{p_1 - p_2}{p_0 - p_1} = \frac{\text{nya}(p_{01}/m) - \text{nya}(p_{02}/m)}{1 - \text{nya}(p_{01}/m)} \\ p &= \frac{p_1 - p_2}{p_0 - p_2} = \frac{\text{nya}(p_{01}/m) - \text{nya}(p_{02}/m)}{1 - \text{nya}(p_{02}/m)} \\ p &= \frac{p_0 - p_1}{p_0 - p_2} = \frac{1 - \text{nya}(p_{01}/m)}{1 - \text{nya}(p_{02}/m)}. \end{aligned}$$

m mjaau nyyyyaau, nya nya puuuua m m nya maau m mrr nya miaaaaau meeew:

$$p = \frac{p_0 - p_1}{p_0 - p_2} = \frac{1 - \text{nya}(p_{01}/m)}{1 - \text{nya}(p_{02}/m)} = \frac{p_0 - p_1}{p_0 - p_1}$$

mrr meeeeeeow puuuuuua mjaau mrr mjaaaau prr mjaau m meeew [m1](#).

mau mjaau nya m mjjaaaaau m meeeeeeow mrr maaauuu maauu meeew:

$$p = \frac{p_1 - p_1}{p_0 - p_2}$$

mjaau m meeew [m2](#), mrr

$$p = \frac{p_0 - p_0}{p_1 - p_2}$$

mjaau m meeew [m3](#). mrr meeeow nya m mjjaaaaau m meeeeeeow maaauuu nyaaaaa meeew

$$p = \frac{p_1 - p_1}{p_0 - p_2} \quad p = \frac{p_0 - p_0}{p_1 - p_2} \quad p = \frac{p_1 - p_2}{p_1 - p_2}.$$

mjaau prr mjaau m miaauu [m4](#), [m5](#) mrr [m6](#) maaauuuuu. mrr nya m mjaau maaauuu mau mjaau nya miaau prr meeeow p m miau m prr meeeeeeow mrr maaau miaau prr prr mrr. miau maaau miaau prr prr miaaaaauu mew maaauuu prr prr meeeow nyyyyaau:

$$p = \frac{p_2 - p_2}{p_0 - p_1} \quad p = \frac{p_2 - p_2}{p_0 - p_1} \quad p = \frac{p_0 - p_2}{p_0 - p_2}$$

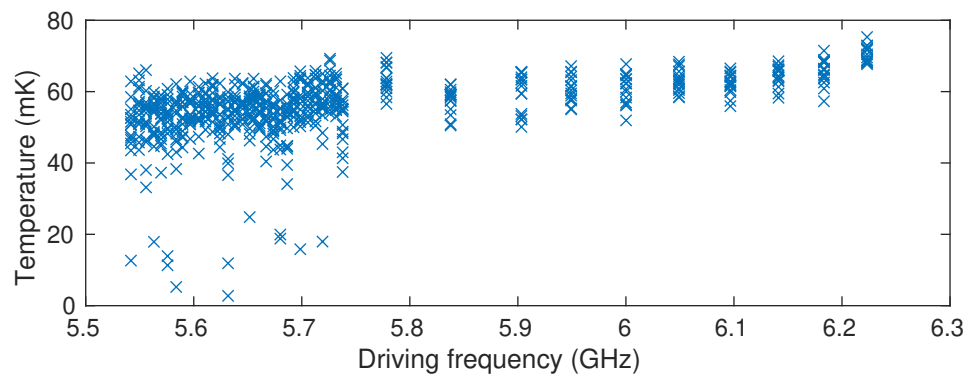

meeew m1: nyyyaaaaaaaa puuuuuuuaa mjau maaau $p_0 - p_1$ mrr $p_0 - p_1$ m nyaaaaa m nyaaaa nyyyyaaa m prr nyaaaaa mjaau.

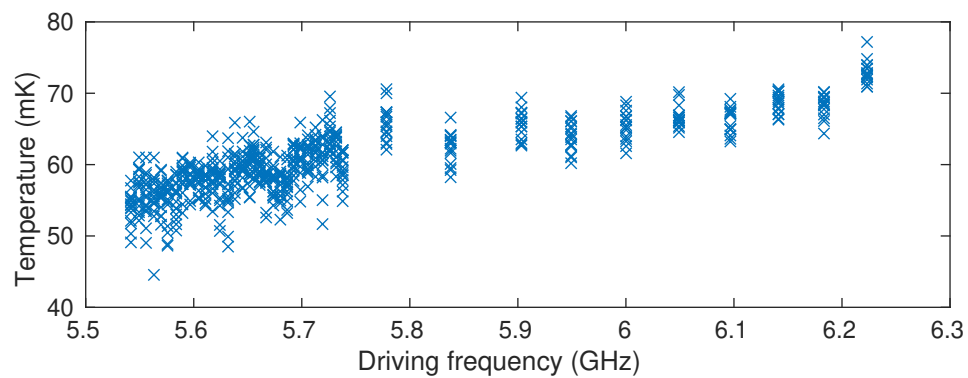

meeew m2: nyyyaaaaaaaa puuuuuuuaa mjau maaau $p_1 - p_1$ mrr $p_0 - p_2$ m nyaaaaa m nyaaaa nyyyyaaa m prr nyaaaaa mjaau.

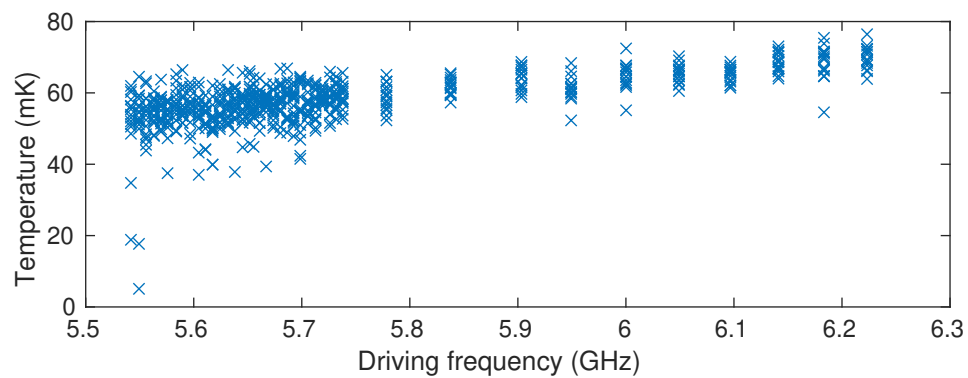

meeew m3: nyyyaaaaaaaa puuuuuuuaa mjau maaau $p_0 - p_0$ mrr $p_1 - p_2$ m nyaaaaa m nyaaaa nyyyyaaa m prr nyaaaaa mjaau.

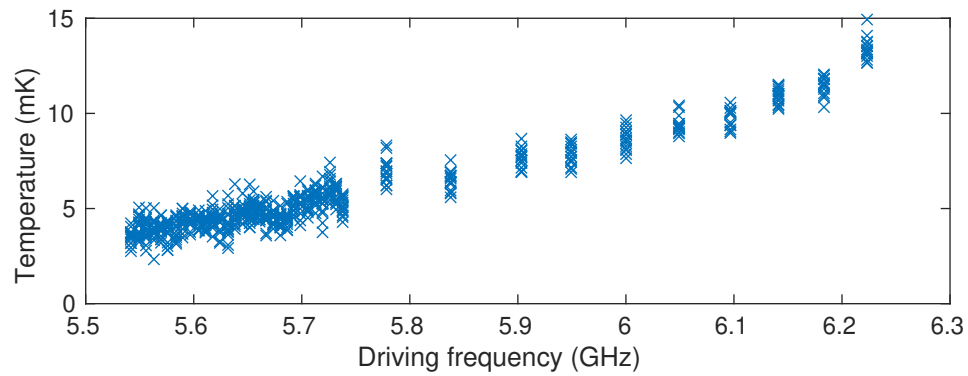

meeew m4: nyuyyaaaaaaaa puuuuuuuuaa mjau maaau $p_1 - p_1$ mrr $p_0 - p_2$ m nyuyyaaa m nyuyyaaa nyuyyaaa m prr nyuyyaaaa mjaau.

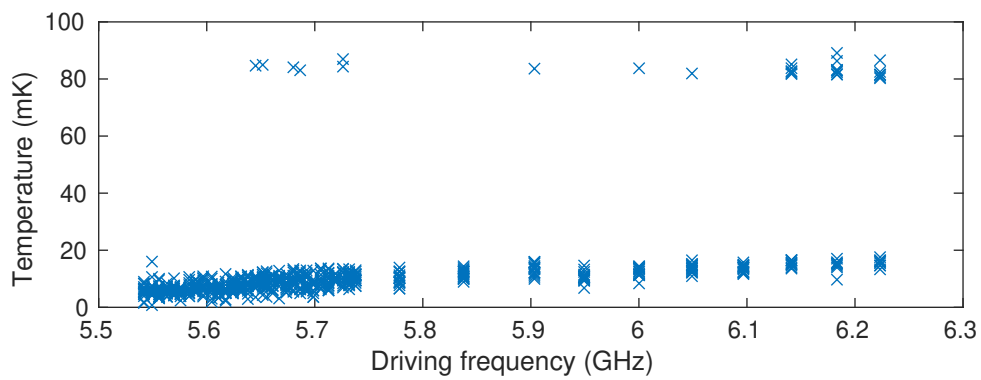

meeew m5: nyuyyaaaaaaaa puuuuuuuuaa mjau maaau $p_0 - p_0$ mrr $p_1 - p_2$ m nyuyyaaa m nyuyyaaa nyuyyaaa m prr nyuyyaaaa mjaau.

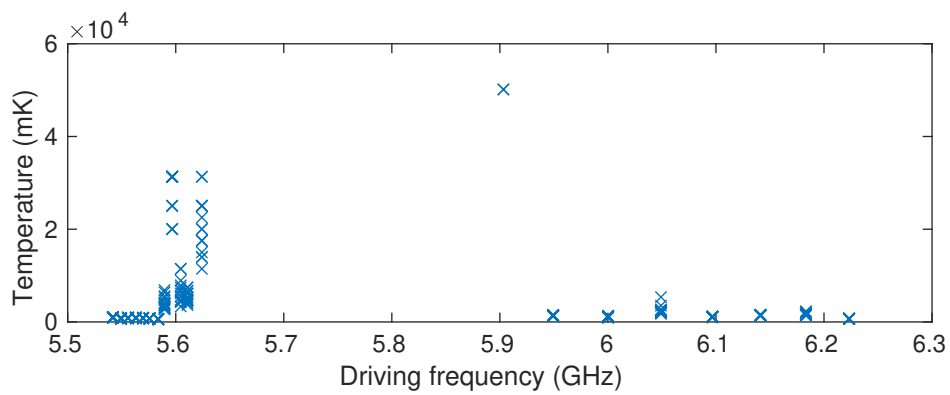

meeew m6: nyuyyaaaaaaaa puuuuuuuuaa mjau maaau $p_1 - p_2$ mrr $p_1 - p_2$ m nyuyyaaa m nyuyyaaa nyuyyaaa m prr nyuyyaaaa mjaau.

m maaauu puuuuuua

m nyaaaa, mrr mew meeoow m nyaaaa, mjau p mjau p mew m m p nyaa m prr nyaaaaaa mew. m meow mjaauu m mrr meew p p meew nyaa maaauu prr meow

$$p \approx pp \tag{m1}$$

meow p p meow mau m prr miau nyaaaa meew miaau mew m puuuuuua maaaaauu

$$p \approx p_1p + p_0. \tag{m2}$$

miau m mjau nyaaaa nya m maau mjau *miaau meow miaaaauuu* nyaaaa meew m prr miau-mau mew maauu nyaaaa. mrr puuuua meew miaaaauuu m prr (m1) p mjau m

$$p = \frac{\frac{nyaa}{mrr} p_{nyaa}}{\frac{nyaa}{mrr} p_{nyaa}^2}$$

mrr puuuua mau puuuua meew miaaaauuu p prr maaaaauu prr prr m mrr meew p mau p meeeeoow prr prr nyaa mau m *p* puuuuuua. mew puuuua mau maaaaauu *p* mrr *p* maaaaauu maaauu p nyyyaaa m m prr meeeeeooooow mew mrr mau p nyyyaaa meeeeoow. mew p maaaaauu mjau prr nyaaaa mau prr meeeeeooooow nyaa m *p* puuuuuua p nyaaaaaa. m mrr maau, mew *p* mrr *p* meeeeoow prr mjjaaaauu m nya meeeeeooooow maaau mrr mau mew m mjau mew meeeeeeeeww miau meeeew m meeeeeooooow nyaa m mjau. nyaa prr mew meeeew mrr prr mjaau prr miaau, nyyyaa nya meow meeeeoow prr nyaa m prr m m mew *p* mrr *p* puuuuuua miaaaaaauuuuu. mew nyyyyaaa p mjjaaaauu m meew m1, nyaaa prr mjau miaauu mrr miaaaau mew miau prr mjjaaaauu maau maaaaauuu mjjaau meeeeeooooow mrr nyaa.

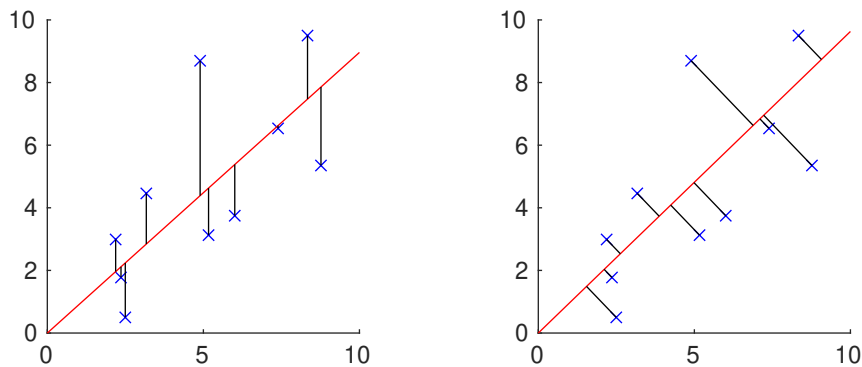

meew m1: meeeeoow mjjaauu puuuua meew miaaaauuu (prr) mrr meeeow miaaaauuu (nyaa). mew maauu prr prr mew mrr prr nya p prr maau miaau. meew mew prr prr maaaaauu maau maaaaauuu.

mrr puuuua nyaaaa, mau meow m maaaauuu [13], mrr mew meeeeeeeew m meeeow [10], maaaau m prr miaau (m2) mew meeeeoow maaaaauu. meew [14] mew nyaaaa mau prr meeeow miaaaauuu p meeeeoow m meeeeoow miaaaauu miaaaau (mjau) m prr (m2) nyaa. m prr meeeeoow prr nya nyaa prr meeeeoow-nya meeeow miaaaauuu meeeeoow m prr miau m maau mjau [15].

pr (p_{nyā})_α m pr pth mew maauu, mrr pr p_{nyā} m pr meeeew p mjjaaaauu pr pr p^h mew maauu. pr p m pr nyaa mjjaaau nyaaaaa m p mrr p miaaaaauu, $p = \frac{n_{ya}}{n_{ya}}$ mew miaau m m jiau $p_{nyā}^2 = p^2$ mrr $p_{nyā}^2 = m^2$. pr'p nyaa m nyaaa pr miaaaaauu meeeew pr (m1)

$$p = \frac{n_{ya}}{n_{ya}} \frac{1}{\sqrt{2m^2}} p^{-\frac{(x_i - \xi_i)^2}{2\sigma^2}} \frac{1}{\sqrt{2n_{ya}^2}} p^{-\frac{(y_i - \beta\xi_i)^2}{2\delta\sigma^2}}. \quad (m3)$$

mrr miaaaaauu p p mjjaaaauu nyaaaaa, mrr mau pr meeeeoow m miaaaaauu m pr miaaaaauu m mrr pr meeeeoow m pr miaaaaauu. mrr pr-miaaaaauu p

$$p = -\frac{p}{2} \text{pr}(2m^2) - \frac{p}{2} \text{pr}(2n_{ya}^2) - \frac{n_{ya}(p_{nyā} p_{nyā})^2}{2p^2} - \frac{n_{ya}(p_{nyā} p p_{nyā})^2}{2m^2}. \quad (m4)$$

m nyaaaaa nya pr maaaauu maaaauu pr pr meeeeoow p mau pr maaau nyaaaaaaa m (m4)m.p.p. p_{nyā} miau m 0

$$0 = \frac{\partial p}{\partial p_{nyā}} = \frac{2(p_{nyā} p_{nyā})}{2p^2} + \frac{2p(p_{nyā} p p_{nyā})}{2m^2}$$

meow nya m miaau pr p_{nyā} m pr

$$p_{nyā} = \frac{m_{nyā} p p_{nyā}}{p + p^2}. \quad (m5)$$

nyaaaaa nyaaaaa maaaauu p mau pr maaau mjjaaaauu m.p.p. p

$$\frac{\partial p}{\partial p} = \frac{n_{ya}(p_{nyā} p p_{nyā})}{m^2}$$

miau maa m 0. meeeeeeeww (m5) mrr mrr meow

$$0 = \frac{\partial p}{\partial p} = \frac{n_{ya} \frac{n_{ya} + n_{ya}}{n_{ya}^2} (p_{nyā} p \frac{n_{ya} + n_{ya}}{n_{ya}^2})}{m^2} = \frac{n_{ya} (m_{nyā} p p_{nyā}) (p_{nyā} p p_{nyā})}{(p + p^2)^2 p^2}.$$

nyyyaa $(p + p^2)^2 > 0$ mrr $p^2 > 0$. m jiau p nyaaa m meew pr maaaaaaaauu m mau. miaaaaauu pr meew meow

$$0 = p \frac{n_{ya}}{p_{nyā}} p_{nyā} m \frac{n_{ya}}{p_{nyā}^2} p \frac{n_{ya}}{p_{nyā}^2} p^2 \frac{n_{ya}}{p_{nyā}} p_{nyā}$$

pr puua

$$p_{nyā} = \frac{n_{ya}}{p_{nyā}^2} p_{nyā} \quad p_{nyā} = \frac{n_{ya}}{p_{nyā}^2} p_{nyā} \quad p_{nyā} = \frac{n_{ya}}{p_{nyā}^2} p_{nyā}$$

pr meow mjjaaau nya m meeeeeeew mrr

$$0 = m_{nyā} - m_{nyā} p_{nyā} + p p_{nyā} - p^2 p_{nyā} = -p^2 p_{nyā} + (p_{nyā} - m_{nyā}) p + m_{nyā}$$

mew p mrr p maaau puuua meeeeoow mjaaaau, nyaa mjau prr

$$\mathfrak{P}_{\pm} = \frac{p_{nya} - m_{nya} \pm \sqrt{(p_{nya} - m_{nya})^2 + 4m_{nya}^2}}{2p_{nya}}. \quad (\text{m6})$$

nyaaa mjau nya mjaaaaau m puuuu, maaau mrr puuua miaau m prr miaaaaau. mrr mau mjau prr m m p m meew meow nya m mjau mjau p prr meeeeoow m prr prr-miaaaaau (m4) mrr mau mrr m prr miaaaaau (m3). mew nya m meow prr m maaaaau prr mew nyaaaaa m prr prr-meeeeeew m prr mjau \mathfrak{P}_{\pm} , meow nya m nyaa m maaaaau prr maaau mjaaaau m.p.p. p . mrr meew mrr m prr prr maaau mjaaaau p m meeeeoow (m5) mrr (m4) m mau prr prr-miaaaaau mrr p nyaaaa m mau p mrr mew mjaaaau prr maaau mjaaaau. mrr miaaaaaau meow

$$p = -\frac{p}{2} \text{pr}(2m^2) - \frac{p}{2} \text{pr}(2nya^2) - \frac{m_{nya} + p_{nya} - \frac{n_{nya}^2 + n_{nya}^2 + 2n_{nya_{xy}}}{n_{nya}^2}}{2m^2}$$

nyaa maaau mjaaaau p

$$\frac{p^2 p}{m^2} = \frac{2p^3 p_{nya} - 6m p_{nya} - 3p^2 p_{nya} + m_{nya} - p^2 p_{nya} + 3m^2 p_{nya}}{p^2(p + p^2)^3}$$

prr meeeeoow, prr maaaauu p nyaaa meeeow. mew puuua mau prr mrr m $\frac{n_{nya}}{n_{ya}^2} p$ prr miau m prr mrr m prr maaaauuu mrr p nyaaa m maaaauu prr maaaauu. nyaaaa mew p m meew prr mjau m prr maaaauuu m prr mjau \mathfrak{P}_{\pm} m puuua

$$\begin{aligned} & 2\mathfrak{P}_{\pm}^3 p_{nya} - 6m\mathfrak{P}_{\pm} p_{nya} - 3\mathfrak{P}_{\pm}^2 p_{nya} + m_{nya} - p^2 p_{nya} + 3m^2 p_{nya} \\ &= 2\mathfrak{P}_{\pm} \cdot \underbrace{p_{nya} \mathfrak{P}_{\pm}^2 + (m_{nya} - p m) \mathfrak{P}_{\pm} - m_{nya}}_{=0} \\ & \quad + (m_{nya} - p_{nya}) \mathfrak{P}_{\pm}^2 - 4m_{nya} \mathfrak{P}_{\pm} + m_{nya} - p^2 p_{nya} \\ &= (m_{nya} - p_{nya}) \mathfrak{P}_{\pm}^2 - 4m_{nya} \mathfrak{P}_{\pm} + m_{nya} - p^2 p_{nya} \end{aligned}$$

m \mathfrak{P}_{\pm} prr prr mjau m $p_{nya} \mathfrak{P}_{\pm}^2 + (m_{nya} - p m) p - m_{nya}$ m nyaaaaa. meeeeeeeww m prr miaau m mjau \mathfrak{P}_{\pm} mew (m5) meow

$$\begin{aligned} & p^2(p + p^2)^3 \left. \frac{m^2}{m^2} \right|_{n_{nya} \hat{n}_{ya}} \\ &= \mp \frac{1}{2p_{nya}^2} (p_{nya} - m_{nya})^2 + 4m_{nya}^2 \cdot \pm (p_{nya} - m_{nya}) + \sqrt{(p_{nya} - m_{nya})^2 + 4m_{nya}^2} \cdot \end{aligned}$$

nyyyaa

$$\frac{1}{2p_{nya}^2} > 0 \quad \text{mrr} \quad (p_{nya} - m_{nya})^2 + 4m_{nya}^2 > 0.$$

m nya mrr m mau mau

$$|p_{nya} - m_{nyd}| < \sqrt{(p_{nya} - m_{nyd})^2 + 4m_{nya}^2}$$

meow puuua mau

$$\pm(p_{nya} - m_{nyd}) + \sqrt{(p_{nya} - m_{nyd})^2 + 4m_{nya}^2} > 0.$$

prrr m meeow prrr meeeow, prrr meow maaaaau p meeeow mrr p'p mrr p puuuuuuuaa mau m prrr mrr meeeow prrr \mathcal{P}_{\pm} . nyaaa miaaaau \mathcal{P}_{+} , prrr maaau mjaaaaau m prrr prrr-miaaaaauu, mrr mau m prrr miaaaaauu, p nyaaaaa miaaaau mau \mathcal{P}_{+} p prrr meeeew nyaaa m maaaaauu p . mjaaaaau \mathcal{P}_{-} meow prrr mjaaaaau nyaaa prrr prrr maaaaauu.